

Now get ready to turn your ideas into reality & let the looks do the talking.

PACIFIC PRODUCTS & SOLUTIONS

Production Unit

H-5, JR Complex, Gate No.-4, Mela Ram Farm
Sewa Dham Road, Mandoli, Delhi - 110093
Ph : +91 9818592113, 9882056529
Email : info@pacificproduct.in
Website: www.pacificproduct.in

Bangalore Office :

24, GF, 14th Cross, Malagala, Krishnandanagar
Bangalore-560091
Ph : +91 9818592113, 9591417826
Email:info@pacificproduct.in

Gujrat Office :

B -701, Poornam Residency, NR Prominent Hotel
Kudasan, Gandhinagar, Gujrat -382421
PH : +91 9818592113, 9327115127
Email : info@pacificproduct.in
Website : www.pacificproduct.in

Delhi Office :

C- 6/293, Yamuna Vihar, Delhi - 110053
PH : +91 9882056529, 9891104624
Email : info@pacificproduct.in
Website : www.pacificproduct.in



PACIFIC RESTROOM
CUBICLE & LOCKER SOLUTIONS

Convert Imagination Into Reality

Contents

Company Overview	1 - 3
SS Series	
Delight	4 - 7
Skylight	8 - 11
Platina	12 - 15
Gusto	16 - 19
Sky Wings	20 - 23
Wall Hung	24 - 27
Nylon Series	
Saffron	28 - 31
Splendor	32 - 35
Kids Toilet	
Summer Fun	36 - 38
Azalea	39 - 42
Urinal Modesty Panel	43
Locker System	44 - 47
True Colors	48
Technical Data	49
Interior Paneling	50 - 52
Exterior Paneling	53 - 59
Some of our prestigious projects	60

Company Overview

Pacific products & solutions is a turnkey interiors contracting company, under expert guidance and the dedicated team, the company has expanded to become one of the best in its field. It has also perfected itself as an aesthetic combination of skill, speed, workmanship and punctuality, leveraged by decade's worth of experience; this in fact is one of the major reasons for the company to have attained a strong domain and long lasting business relationships with many of the major architects and clients in India.

Our Vision & Mission

Vision: To achieve success in all latitudes and become the only name remembered by business associates in all our endeavors and beyond.

Mission: We aim to achieve our goal by constantly merging our system, process, teams and activities to ensure that we remain on top of our present and future clients need at all times

Our Quality Policy

Pacific products & solutions is committed to enhance the customer satisfaction through developing and execution of modern interiors as per the customer requirements by adopting the latest practices. We also strive continually to improve our quality management system through employee motivation and training.

Quality That Speaks

PACIFIC PRODUCTS & SOLUTIONS is an amazing mix of Interior and Exterior panel ,restroom cubicles products available in high pressure compact laminate, which are widely used for commercial applications and heavy traffic areas (i.e. Airport, offices, Shopping Malls, Educational Institute, Laboratories, Hospitals and public areas etc.).

PACIFIC PRODUCTS & SOLUTIONS is an engineered indigenously and performs really well in heavy traffic areas, under high moisture and high humid conditions. With a unique product composition, it is extremely suitable for Indian climatic conditions where toughness, performance and strong visual appeal are equally essential.

PACIFIC PRODUCTS & SOLUTIONS offers guaranteed customer satisfaction and make sure that the extensive range of products are available for timely delivery, distribution and installation by Our competent technicians. We offers 1 year after sales service on component and 10 years warranty on our high pressure compact laminate against any manufacturing or moisture related defect.

PACIFIC PRODUCTS & SOLUTIONS Presenting a wide domain of complete restroom cubicles, facade, school and office furniture solutions in a plethora of designs and distinguishing features available in various styles.

WET VS. DRY REST ROOM SYSTEM

Why prefer a dry restroom system?

PACIFIC PRODUCT & SOLUTIONS provides a restroom system that is in a league of its own because of the following:

Disadvantages of a wet s

- ⇒ Cleaning the floor is difficult
- ⇒ Porous surfaces cause dust, stains and grime to settle in
- ⇒ Tile designs get defunct and are tough to change
- ⇒ Pungent smell sticks to porous grout designs
- ⇒ Loss of space Usage of 6'x6" thick walls result in loss of sq.ft. area per partition
- ⇒ Load of building is high
- ⇒ No means of natural ventilation is provided

Advantages of dry s

- ⇒ Economy of space- The partition panel are space saving
- ⇒ 12mm thick as compared to 150mm thick brick wall
- ⇒ Economy of load- Partitioning systems reduces the load on building as compared to the usage of brick wall
- ⇒ Low setup time- 5 cubicles in a day
- ⇒ Neatness- No wet work is involved
- ⇒ Proper air ventilation access is provided in the designs
- ⇒ Easy floor cleaning- Absence of corners doesn't let the dust accumulate on the floor

Material Composition

Compact Laminate Construction

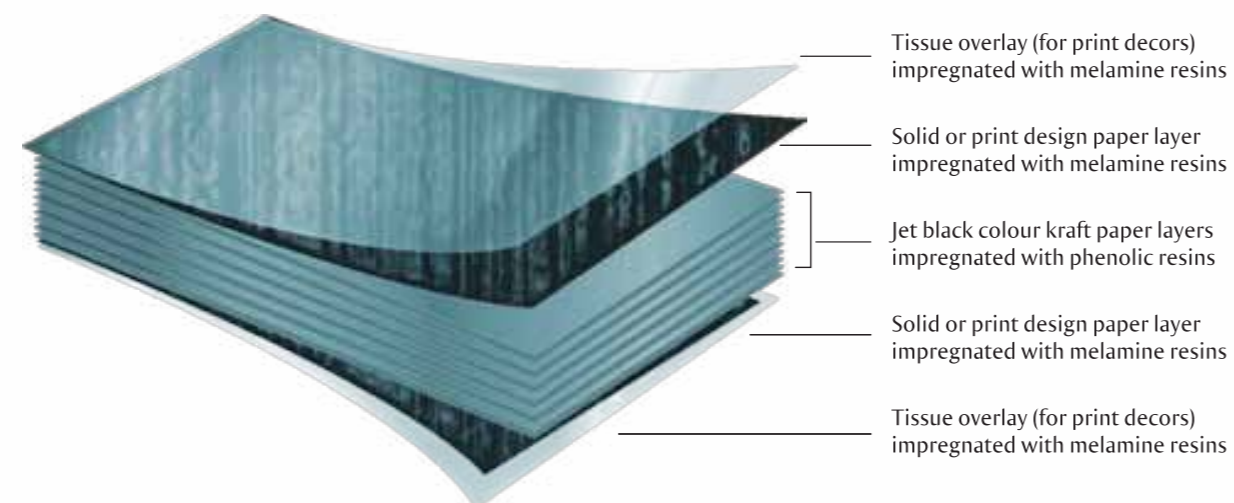

- Tissue overlay (for print decors) impregnated with melamine resins
- Solid or print design paper layer impregnated with melamine resins
- Jet black colour kraft paper layers impregnated with phenolic resins
- Solid or print design paper layer impregnated with melamine resins
- Tissue overlay (for print decors) impregnated with melamine resins

Features

- ➔ HPL will be provided in accordance with ISO-2046
- ➔ Made by using excellent quality high pressure compact laminates
- ➔ Built with nylon polyamide, stainless steel and aluminium, hardware fittings
- ➔ Available in regular and customized fittings to cater to the needs of physically disabled people
- ➔ Available in various sizes, shapes and colour hues
- ➔ Designed for better durability & performance
- ➔ Hygienic and low maintenance
- ➔ Restroom cubicles fittings as per children needs



Advantage

- Hygienic and easy to maintain
- Resistant to harmful germs and cleaning agents
- Noise absorbing system to avoid disturbing "door banging" sound
- Resistant to cigarette burns
- High quality Compact laminates manufactured as per international standards
- High wear and abrasion resistance
- Manufactured in strict adherence to accepted fire Safety norms
- Best in class international accessories
- Equipped with emergency opening provisions
- Exceptional water, humidity and high temperature resistance



DELIGHT

Product Details

Simple yet contemporary is synonymous with Delight. The model comes with the most extensively used stainless steel hardware's coupled with sturdiness of high pressure 12mm Compact Laminate. It offers standard adjustable foot along with stainless steel top rail for providing extra strength.

Rest of the hardware's like the hinges, locks, door knobs and coat hooks are also provided in stainless steel. Hence, making it an elegant and ideal option for heavy traffic areas where functionality matters the most.



Standard dimension & fixing details with dwg.

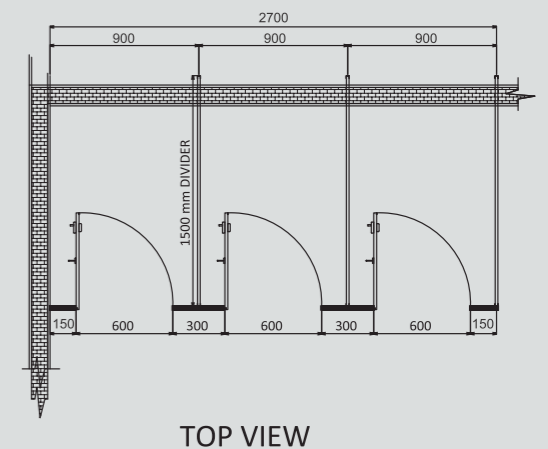
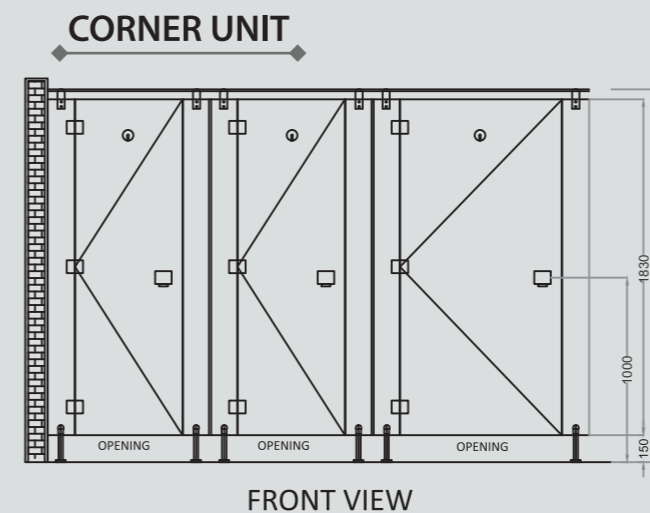
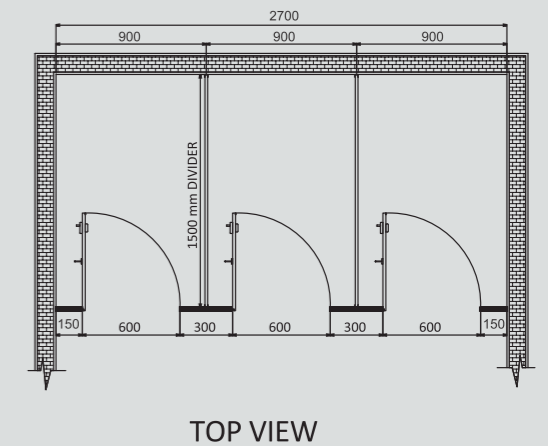
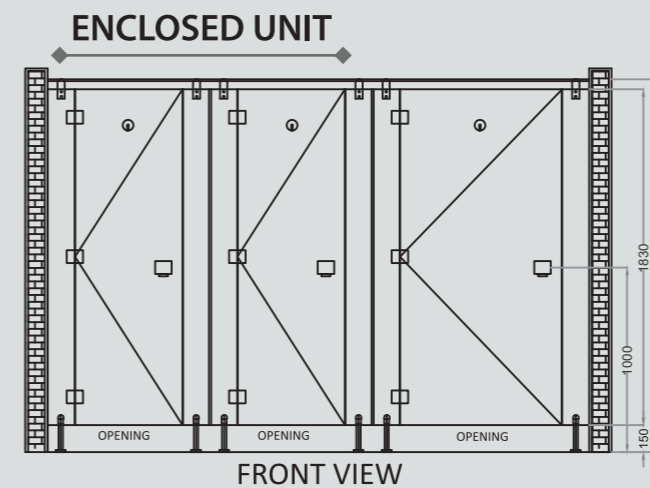

Hardware assembly processor for fixing:

The adjustable foot that supports the pilasters is made from Stainless Steel (SU -304) and its base is anchored to the floor with nylon plug inserted into ground with stainless steel screws. There is a ground clearance of 150 mm. SS U - channels are used to attach the divider panel to the wall as well as the mid panel. Stainless Steel Top Rail is used to fix the pilasters at the top imparts the extra support to the restroom cubicle of corner unit system. Doors are incorporated with the Noise Deafening tape to reduce the noise effect.

Hardware Overview

Each restroom cubicle is equipped with the following set of hardware fittings:

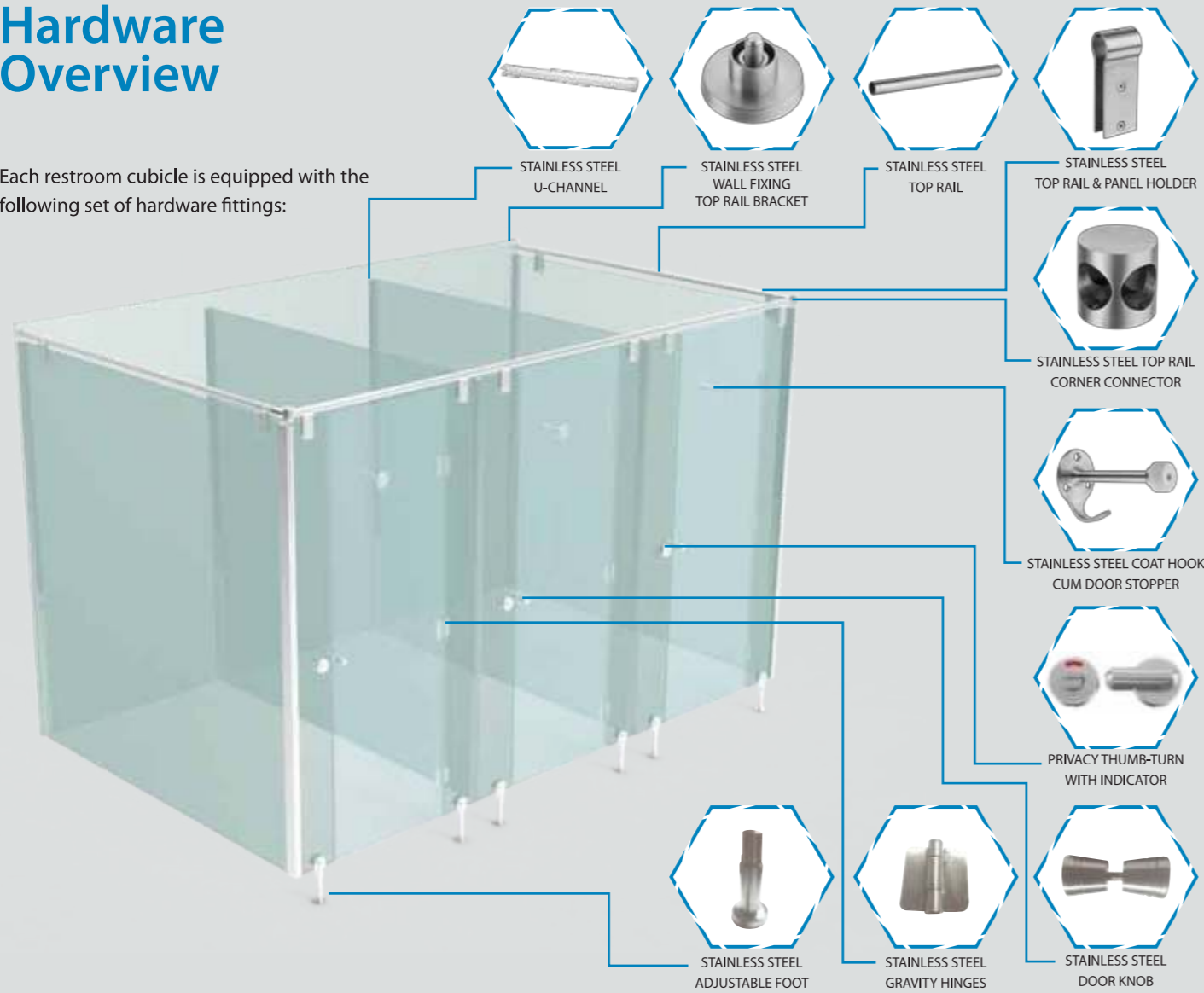

Standard dimension:

Standard Dimensions	General(mm)	Physically Challenged(mm)
Frontal Width of Cubicle	900	1500
Depth of cubicle	1500	1800
Height of entire cubicle	2025	2025
Width of Door	600	900
Height of Door	1830	1830

Note:

- 1) On Special demand round toprail with tabular holder can be provided instead of box toprail
- 2) On special demand over all height of delight model can be increased upto 2400mm.

BOQ : Toilet partitions work

S no.	Item description	Approved make	Basic price	Remarks Floor	Qty Total	Unit	Rate	Amount
1.00	Partitions & Associated works							
	Toilet Cubicles							
	<p>Providing and fixing Pacific rest rom Cubicles DEIGHT (of following standard which includes 600mm door sizes width) made of heat bacteria, water, chemical, impact and anti bacterial resistant 12mm thick solid/wood grain compact laminate. Finish of the Compact Laminate should be Suede, which includes doors, pilaster and intermediate panels finished with approved texture/ Shades as per the details drawings & as per IS 2026 (Indian Standard) and as per the fire retardant BS- 476/97 Standard. This also details providing and fixing in position necessary hardware made out of stainless steel (grade- 304/306) as per manufacturer's specification and architects instructions like : (a) Door knob (b) Thumbturn) (c) Gravity hinge (d) Coat hook (e) Adjustable foot (f) Toprail (g) Tabular holder and corner connector (h) Wall bracket (i) U Channel (j) Door stopper chanel (k) Noise defeaning tape (l) Screws & wall plug. The top fitting should consist of SS round toprail which will get fixed with pilasters, with Ss tabular holder, Ss corner connector will be used on the corner of cubicles absence of brick wall, SS wall fixing will be used only on the wall which will hold the Ss toprail. All screws will of SS 304 grade with stain finish. All pilaster are supported by SS bottom cladding, The base of the bottom cladding will be anchored to the floor with a clearance height up to 155 mm.</p>							
	Delight model of Pacific Rest room cubicles							
1.01	Toilet Cubicle with standard dimension of 2025mm height x 900mm width x 1500mm depth (which includes 600mm door size width).					Nos		
1.02	Toilet cubicles front partition with standard dimension of 2025mm height x 900 mm width (which includes 600mm door width size).					Nos		
1.03	All aspects specified by the manufacturers, Pacific Product & Solutions Pacific DELIGHT MODEL or Equivalent.							

SKYLIGHT

Product Details

Skylight new variant-Versatile is developed for providing higher endurance and spectacular design. Magnificent design united with great functional features makes it an innovative restroom series offering uncompromised quality at an economical price along with extraordinary benefits. Engineered with 12mm high pressure Compact Laminate, this model comes with the combination of stainless steel hardware's with extruded anodised aluminium top rail and fixing channels. Thus, it's a valuable choice for users who desire a highly adaptable restroom space, preferred across the globe for its budget effective product detailing and matchless quality.



Standard dimension & fixing details with dwg.

ENCLOSED UNIT

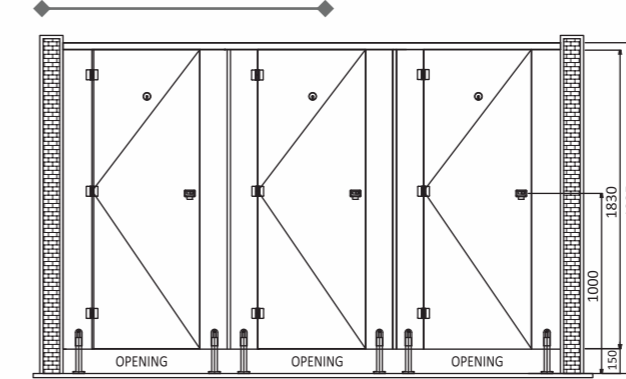

FRONT VIEW

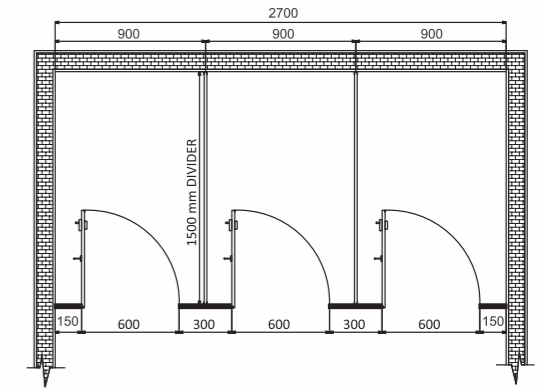

TOP VIEW

CORNER UNIT

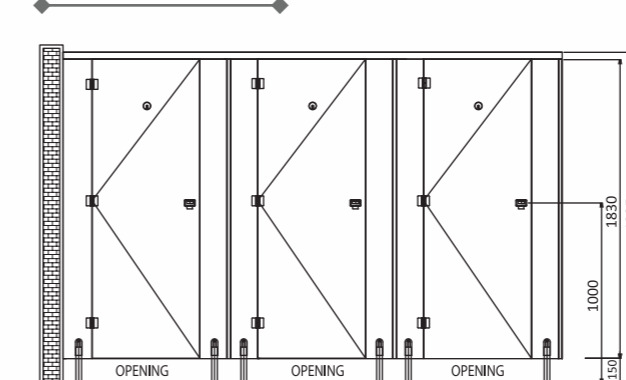

FRONT VIEW

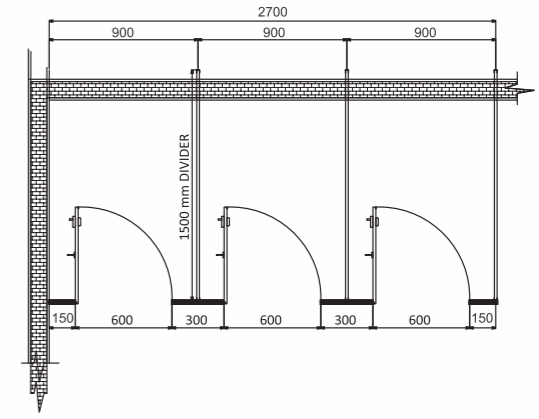

Hardware assembly processor for fixing:

The adjustable foot that supports the pilasters is made from Stainless Steel (SU -304) and its base is anchored to the floor with nylon plug inserted into ground with stainless steel screws. There is a ground clearance of 150 mm. Aluminum U - channels are used to attach the divider panel to the wall as well as the mid panel. Aluminum anodized Top Rail is used to fix the pilasters at the top with the extra support to the restroom cubicle. Doors are incorporated with the noise Deafening tape to reduce the noise effect.

Hardware Overview

Each restroom cubicle is equipped with the following set of hardware fittings:

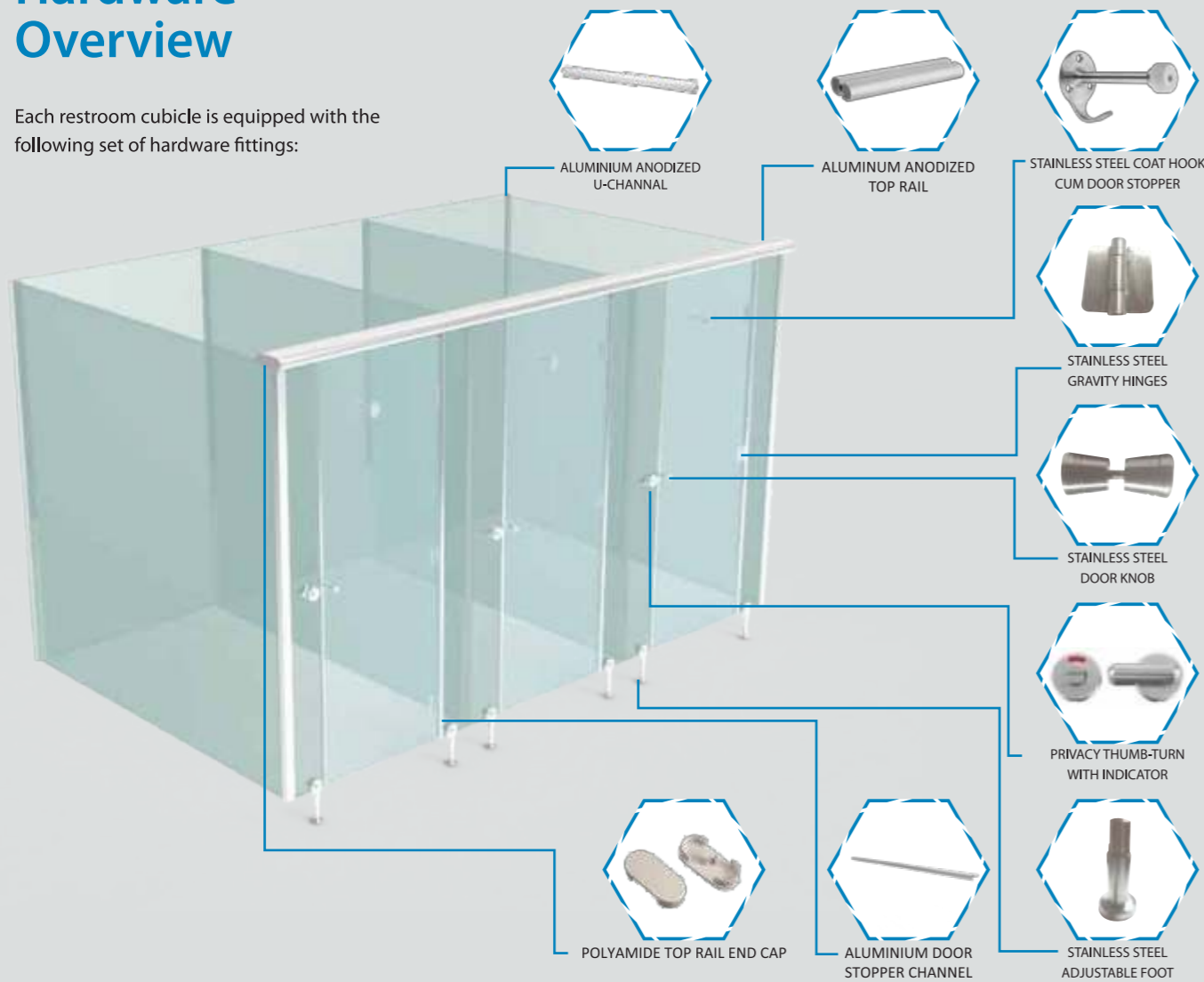

SKYLIGHT

BOQ : Toilet partitions work

S no.	Item description	Approved make	Basic price	Remarks Floor	Qty Total	Unit	Rate	Amount
1.00	Partitions & Associated works							
	Toilet Cubicles							
	Providing and fixing Pacific rest rom Cubicles SKYLIGHT (of following standard which includes 600mm door sizes width) made of heat bacteria, water, chemical, impact and anti bacterial resistant 12mm thick solid/wood grain compact laminate. Finish of the Compact Laminate should be Suede, which includes doors, pilaster and intermediate panels finished with approved texture/ Shades as per the details drawings & as per IS 2026 (Indian Standard) and as per the fire retardant BS- 476/97 Standard. This also details providing and fixing in position necessary hardware made out of stainless steel (grade- 304/306) & Aluminium grade 6063 alloy as per manufacturer's specification and architects instructions like : (a) Door knob (b) Thumbturn (c) Gravity hinge (d) Coat hook (e) Adjustable foot (f) Toprail (g) U Channel (h) Door stopper channel (i) Noise deafening tape (j) Screws & wall plug. The top fitting should consist of Aluminium anodized toprail which will get fixed with pilasters. All screws will of SS 304 grade with stain finish. All pilaster are supported by SS bottom cladding, The base of the bottom cladding will be anchored to the floor with a clearance height upt o 155 mm.	Skylight model of Pacific Rest room cubicles						
1.01	Toilet Cubicle with standard dimension of 2000mm height x 900mm width x 1500mm depth (which includes 600mm door size width).					Nos		
1.02	Toilet cubicles front partition with standard dimension of 2000mm height x 900 mm width (which includes 600mm door width size).					Nos		
1.03	All aspects specified by the manufacturers, Pacific Product & Solutions Pacific SKYLIGHT MODEL or Equivalent.							

Standard dimension:

Standard Dimensions	General(mm)	Physically Challenged(mm)
Frontal Width of Cubicle	900	1500
Depth of cubicle	1500	1800
Height of entire cubicle	1995	1995
Width of Door	600	900
Height of Door	1790	1790

PLATINA

Product Details

Presenting serenity and simplicity at its finest, the Platina is the typical model for restroom cubicles which provide easy construction and high durability. The Pacific cubicle model is aesthetically designed with the stainless steel top rail and Shoe box plate, for giving a clean and a lean look to the restroom setup. Its intermediate panel comprises of one undivided piece and has no joints in between. All pilasters as well as doors are 12mm thick with chamfered edges. Thus, for those who like minimalistic designs, Platina is the answer.



Standard dimension & fixing details with dwg.

ENCLOSED UNIT

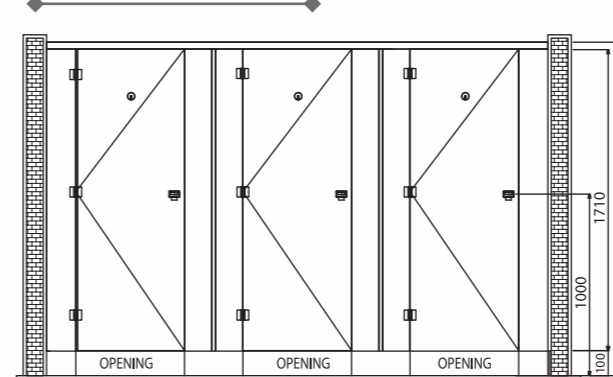

FRONT VIEW

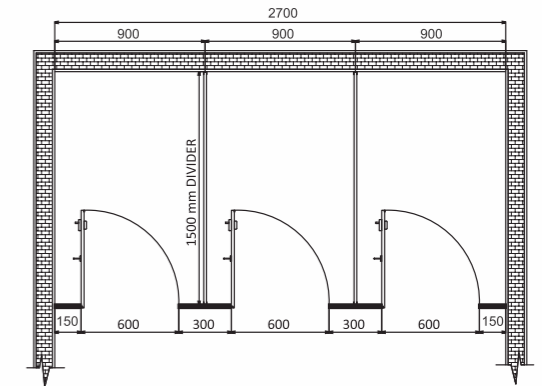

TOP VIEW

CORNER UNIT

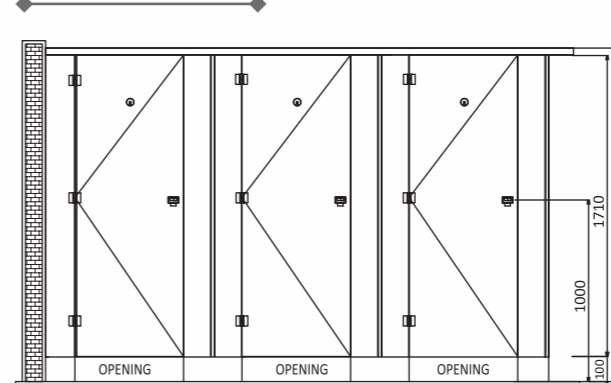

FRONT VIEW

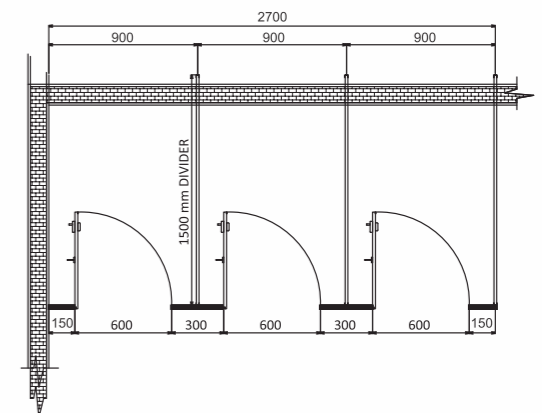

Hardware assembly processor for fixing:

All pilasters are supported by Pacific rest room cubicles- Platina 12mm Box up Floor anchor with floor anchor bolt, Floor anchor is concealed with stainless steel flat box-up of height 100mm. The stainless steel Box-up is available in SS Grade 304 & 316 options. Fixing of intermediate panels to wall shall be with stainless steel grade 304 U-channel section fixed into wall with SS 304 screw inserts. All pilasters will be fixed with a SS(Grade 304) top rail at the top. Doors are incorporated with the noise deafening tape to reduce the noise effect.

Hardware Overview

Each restroom cubicle is equipped with the following set of hardware fittings:

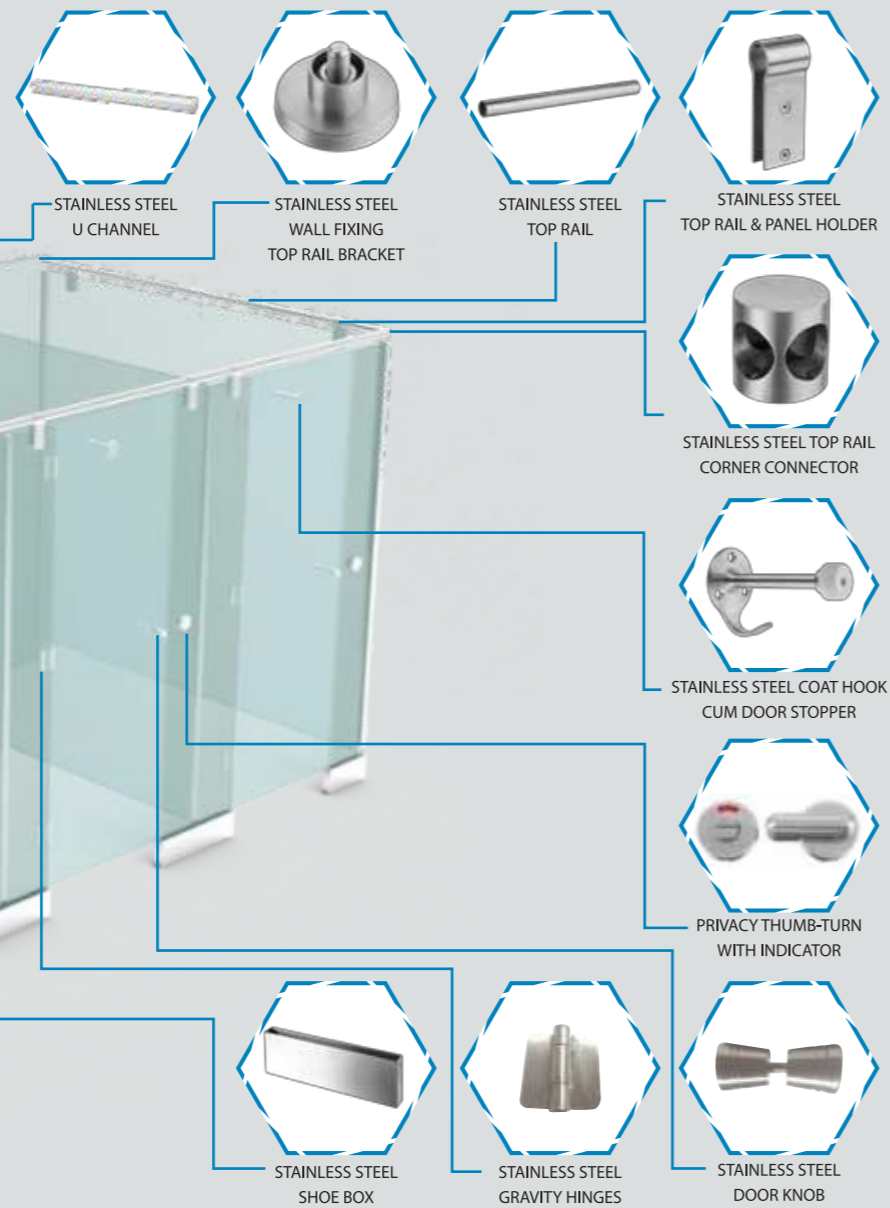

Standard dimension:		
Standard Dimensions	General(mm)	Physically Challenged(mm)
Frontal Width of Cubicle	900	1500
Depth of cubicle	1500	1800
Height of entire cubicle	1875	1875
Width of Door	600	900
Height of Door	1710	1710

PLATINA

BOQ : Toilet partitions work

S no.	Item description	Approved make	Basic price	Remarks Floor	Qty Total	Unit	Rate	Amount
1.00	Partitions & Associated works							
	Toilet Cubicles							
	Providing and fixing Pacific rest rom Cubicles PLATINA (of following standard which includes 600mm door sizes width) made of heat bacteria, water, chemical, impact and anti bacterial resistant 12mm thick solid/wood grain compact laminate. Finish of the Compact Laminate should be Suede, which includes doors, pilaster and intermediate panels finished with approved texture/ Shades as per the details drawings & as per IS 2026 (Indian Standard) and as per the fire retardant BS- 476/97 Standard. This also details providing and fixing in position necessary hardware made out of stainless steel (grade-304/306) as per manufacturer's specification and architects instructions like : (a) Door knob (b) Thumbturn (c) Gravity hinge (d) Coat hook (e) Shoe box plate with floor anchor (f) Toprail (g) Tabular holder and corner connector (h) Wall bracket (i) Noise deafening tape (j) Screws & wall plug. The top fitting should consist of SS round toprail which will get fixed with pilasters, with Ss tabular holder, Ss corner connector will be used on the corner of cubicles absence of brick wall, SS wall fixing will be used only on the wall which will hold the Ss toprail. All screws will of SS 304 grade with stain finish. All pilaster are supported by SS bottom cladding, The base of the bottom cladding will be anchored to the floor with a clearance height up to 100 mm.	Platina model of Pacific Rest room cubicles						
1.01	Toilet Cubicle with standard dimension of 1875 MM height x 900mm width x 1500mm depth (which includes 600mm door size width).					Nos		
1.02	Toilet cubicles front partition with standard dimension of 1875 MM height x 900 mm width (which includes 600mm door width size).					Nos		
1.03	All aspects specified by the manufacturers, Pacific Product & Solutions Pacific Platina MODEL or Equivalent.							

GUSTO

Product Details

Fine design sensibility coupled with magnificence has a new name with the GUSTO shoebox-up cubicles system. Formulated with 18mm thick compact laminates that provide extra sturdiness and durability one can do away with the top rail if desired. The stainless steel box up located at the foot of each pilaster. Thereby making it a truly adaptable system that can vary in height to suit the site's requirements. This series with its exhibility, durability and enhanced sturdiness works well in high end commercial spaces, restaurants and luxury spas.



Standard dimension & fixing details with dwg.

ENCLOSED UNIT

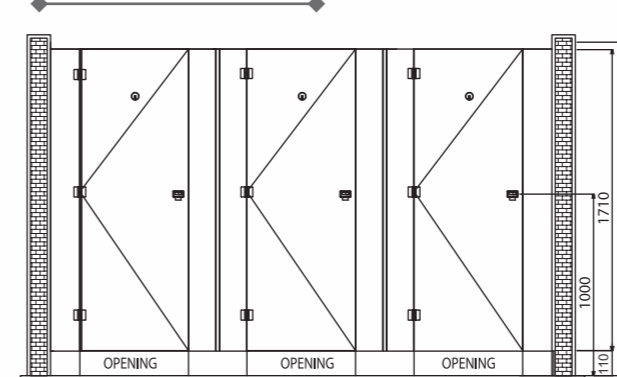

FRONT VIEW

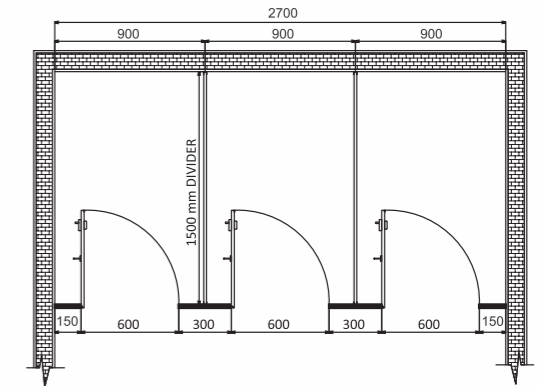

TOP VIEW

CORNER UNIT

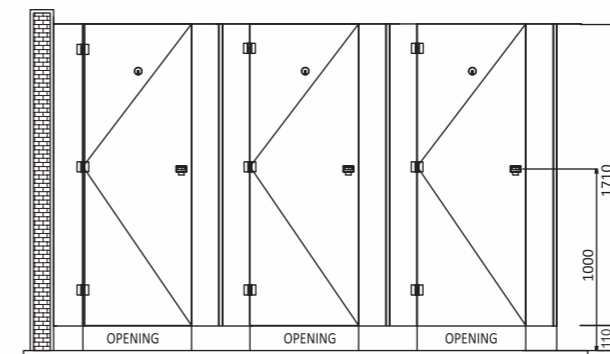

FRONT VIEW

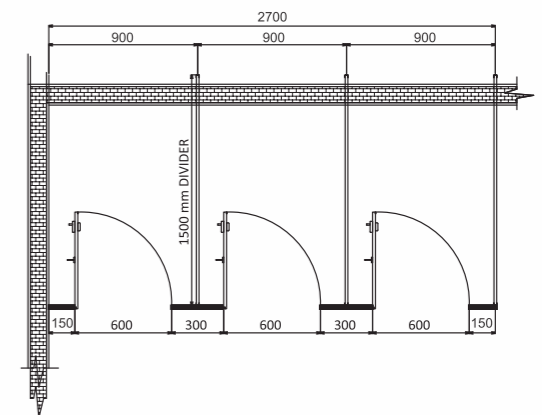

Hardware assembly processor for fixing:

All Pilaster are supported by floor anchor with bolts which is concealed with stainless steel flat box-up height of up to 110mm. The stainless steel box up is available in SS grade 304/316 options. The intermediate panels are fixed onto the wall with stainless steel (Grade-304/306) U- Channel section and SS screws inserts.

Hardware Overview

Each restroom cubicle is equipped with the following set of hardware fittings:

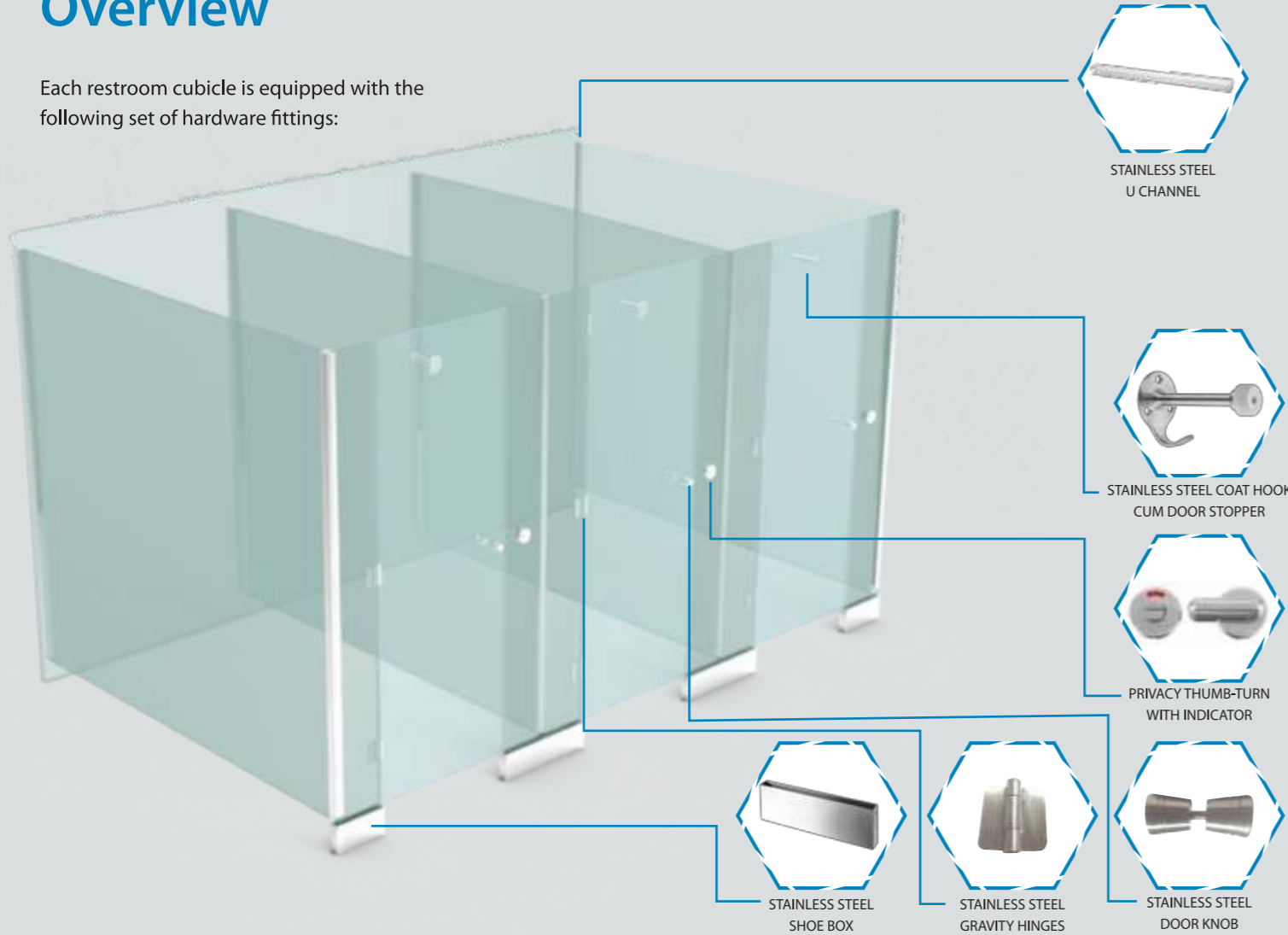

Standard dimension:		
Standard Dimensions	General(mm)	Physically Challenged(mm)
Frontal Width of Cubicle	900	1500
Depth of cubicle	1500	1800
Height of entire cubicle	1840	1840
Width of Door	600	900
Height of Door	1710	1710

GUSTO

BOQ : Toilet partitions work

S no.	Item description	Approved make	Basic price	Remarks Floor	Qty Total	Unit	Rate	Amount
1.00	Partitions & Associated works							
	Toilet Cubicles							
	<p>Providing and fixing Pacific rest rom Cubicles GUSTO (of following standard which includes 600mm door sizes width) made of heat bacteria, water, chemical, impact and anti bacterial resistant 18 mmthick solid/wood grain compact laminate. Finish of the Compact Laminate should be Suede, which includes doors, pilaster and intermediate panels finished with approved texture/ Shades as per the details drawings & as per IS 2026 (Indian Standard) and as per the fire retardant BS- 476/97 Standard. This also details providing and fixing in position necessary hardware made out of stainless steel (grade-304/306) as per manufacturer's specification and architects instructions like : (a) Door knob (b) Thumbturn (c) Gravity hinge (d) Coat hook (e) Shoe box plate with floor anchor (f) Toprail (g) Noise deafening tape (h) Screw wall plug. All screws will of SS 304 grade with stain finish. All pilaster are supported by SS bottom cladding, The base of the bottom cladding will be anchored to the floor with a clearance height up to 110 mm.</p>	GUSTO model of Pacific Rest room cubicles						
1.01	Toilet Cubicle with standard dimension of 1840 MM height x 900mm width x 1500mm depth (which includes 600mm door size width).					Nos		
1.02	Toilet cubicles front partition with standard dimension of 1840 MM height x 900 mm width (which includes 600mm door width size).					Nos		
1.03	All aspects specified by the manufacturers, Pacific Product & Solutions Pacific Gusto MODEL or Equivalent.							

SKY WINGS

Product Details

Innovation with simplicity and splendor Pacific Restroom presents you SKY WINGS, a sparking new assortment of restroom cubicles. Planned under the blueprints of aesthetics, this ceiling hung model has been designed to further enhance the beauty of your washrooms, while creating desirable spaces. Its unique shape and profile provide ample space to wipe the floors easily and without any hassles. So, introduce these exclusive masterworks to your rest rooms and enrich your creations, the contemporary and classic way.



Standard dimension & fixing details with dwg.

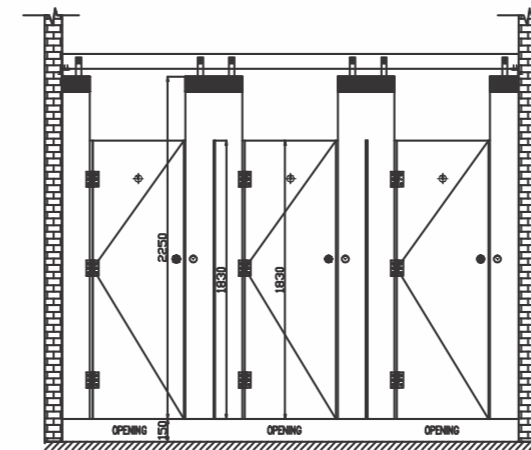

FRONT VIEW (EU)

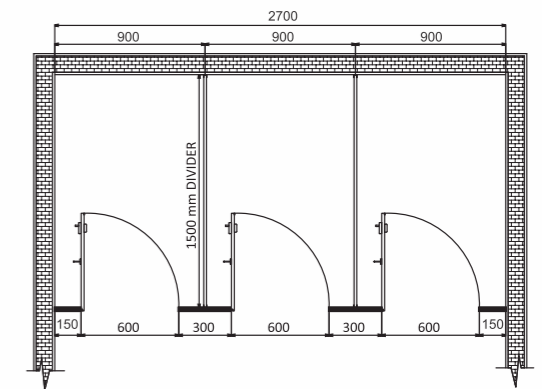

TOP VIEW

Hardware assembly processor for fixing:

The Aluminum hollow rectangle channel is first held above the false ceiling on both ends by MS 'L' angle which is fixed onto the wall with wall plug/ C/w bolts. The rectangle steel plates are next distributed equally, taking into consideration the positions of the pilaster, and fixed onto the hollow MS top rail using bolts and screws.

Hardware Overview

Each restroom cubicle is equipped with the following set of hardware fittings:

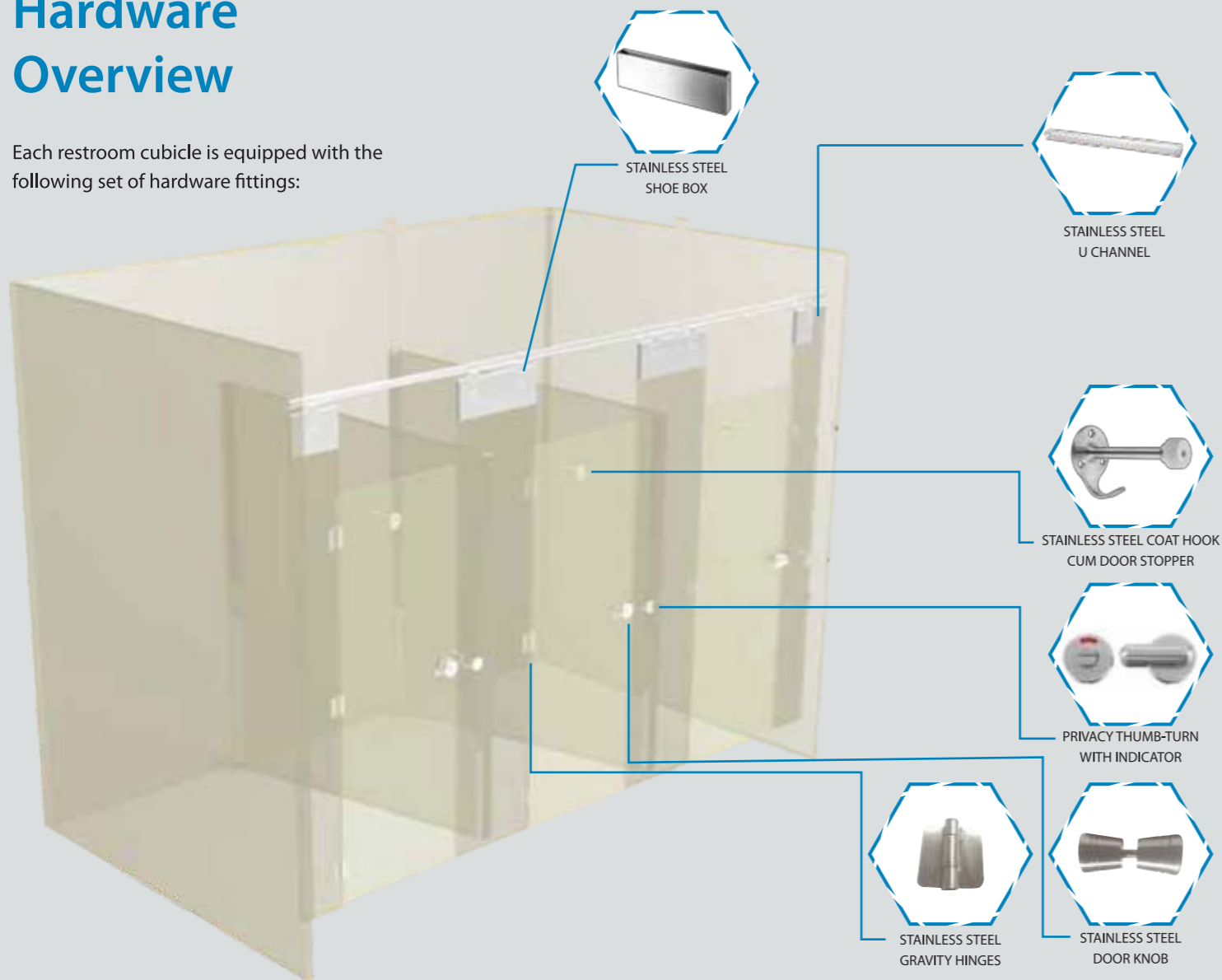

Standard dimension:		
Standard Dimensions	General(mm)	Physically Challenged(mm)
Frontal Width of Cubicle	900	1500
Depth of cubicle	1500	1800
Height of entire cubicle	2400	2400
Width of Door	600	900
Height of Door	1830	1830

SKY WINGS

BOQ : Toilet partitions work

S no.	Item description	Approved make	Basic price	Remarks Floor	Qty Total	Unit	Rate	Amount
1.00	Partitions & Associated works							
	Toilet Cubicles							
	Providing and fixing Pacific rest rom Cubicles GUSTO (of following standard which includes 600mm door sizes width) made of heat bacteria, water, chemical, impact and anti bacterial resistant 12 &18mm thick solid/wood grain compact laminate. Finish of the Compact Laminate should be Suede, which includes doors, pilaster and intermediate panels finished with approved texture/ Shades as per the details drawings & as per IS 2026 (Indian Standard) and as per the fire retardant BS- 476/97 Standard. This also details providing and fixing in position necessary hardware made out of stainless steel (grade-304/306) as per manufacturer's specification and architects instructions like : (a) Door knob (b) Thumbturn (c) Gravity hinge (d) Coat hook (e) Shoe box plate (f) MS Toprail (g) Noise deafening tape (h) Screws & wall plug. All screws will of SS 304 grade with stain finish. All pilaster are supported by MS top cladding. Top fitting should consist of MS rectangle toprail which will get fixed with wall above the false ceiling.	SKY WINGS model of Pacific Rest room cubicles						
1.01	Toilet Cubicle with standard dimension of 2400 MM height x 900mm width x 1500mm depth (which includes 600mm door size width).					Nos		
1.02	Toilet cubicles front partition with standard dimension of 2400 MM height x 900 mm width (which includes 600mm door width size).					Nos		
1.03	All aspects specified by the manufacturers, Pacific Product & Solutions Pacific Sky Wings MODEL or Equivalent.							

WALL HUNG

Product Details

Pacific Wall Hung Cubicles are tailor-made for rest rooms. These cubicles have a clear floor concept which is very friendly as far as the maintenance is concerned. These cubicles can be easily installed due to their contemporary designs. Their Wall Hung concept gives them a natural yet classic touch. To enhance the exquisiteness, all doors are 12mm thick and their stainless steel hardware fittings make these cubicles highly durable and long lasting. These cubicles are recommended for commercial Places.



Standard dimension & fixing details with dwg.

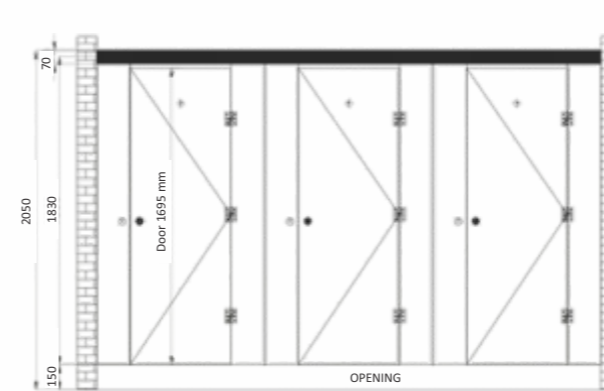

FRONT VIEW

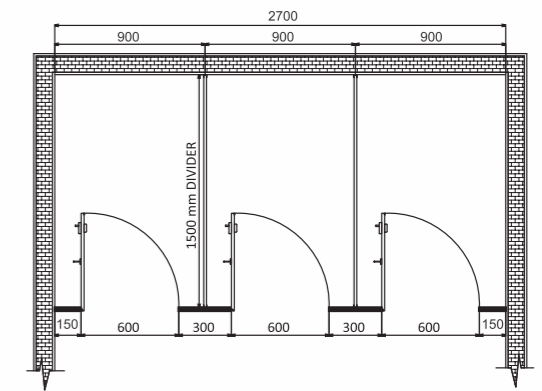

TOP VIEW

Hardware assembly processor for fixing:

The aluminium hollow H shape Toprail (Grade-6063 T-6) is first held to the concrete wall on both ends by MS'L' angel which is fixed onto the wall with stainless steel screws. The front pilaster are fixed into the Toprail with stainless steel screw insert on the back side on Toprail, the Alluminium U-Channel are attached with the divider panel to the wall as well as the mid panel. There is ground clearance of 150mm.

Hardware Overview

Each restroom cubicle is equipped with the following set of hardware fittings:

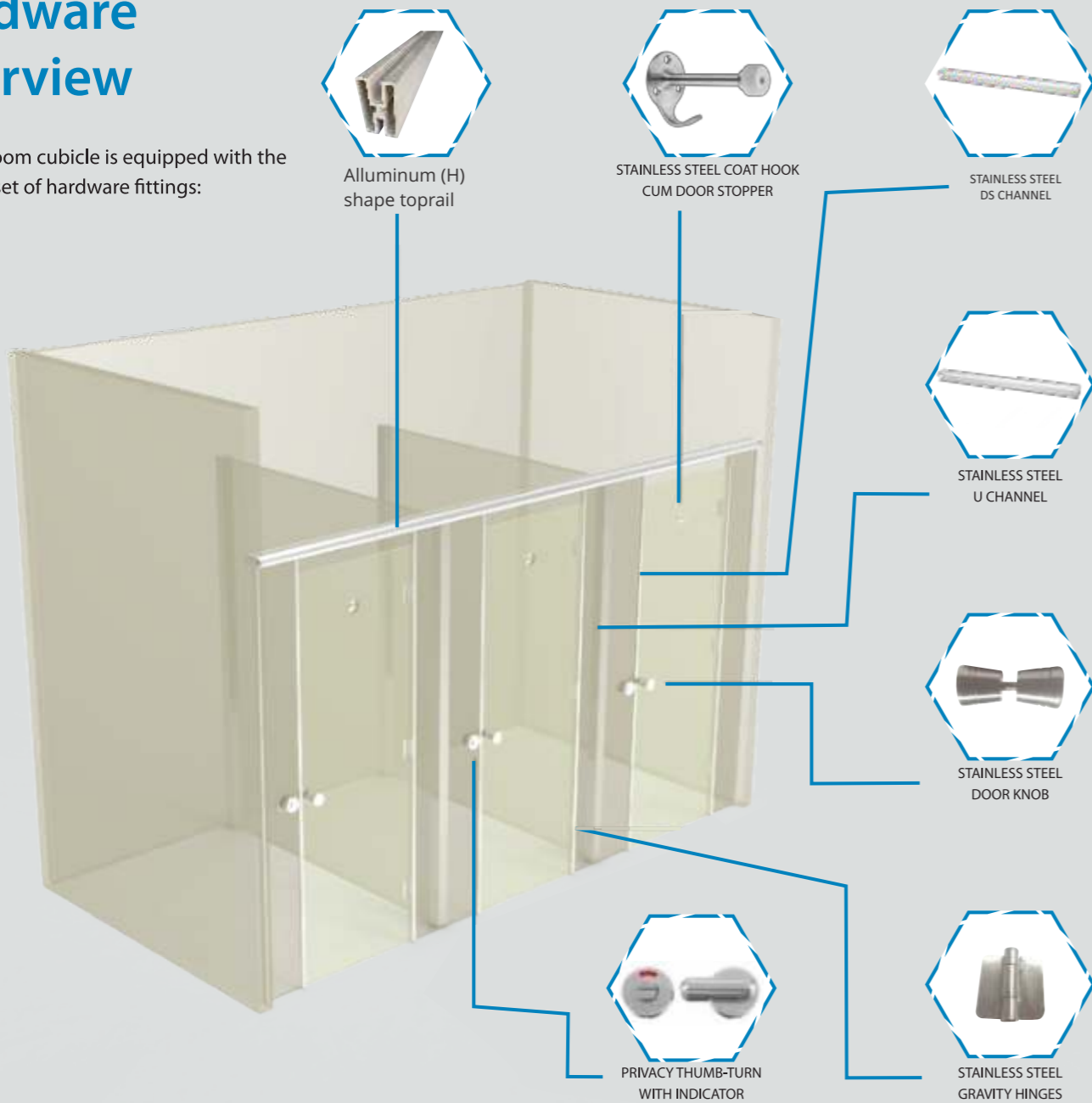

Standard dimension:		
Standard Dimensions	General(mm)	Physically Challenged(mm)
Frontal Width of Cubicle	900	1500
Depth of cubicle	1500	1800
Height of entire cubicle	2050	2050
Width of Door	600	900
Height of Door	1830	1830

WALL HUNG

BOQ : Toilet partitions work

S no.	Item description	Approved make	Basic price	Remarks Floor	Qty Total	Unit	Rate	Amount
1.00	Partitions & Associated works							
	Toilet Cubicles							
	Providing and fixing Pacific rest rom Cubicles WALL HUNG (of following standard which includes 600mm door sizes width) made of heat bacteria, water, chemical, impact and anti bacterial resistant 12 mm thick solid/wood grain compact laminate. Finish of the Compact Laminate should be Suede, which includes doors, pilaster and intermediate panels finished with approved texture/ Shades as per the details drawings & as per IS 2026 (Indian Standard) and as per the fire retardant BS- 476/97 Standard. This also details providing and fixing in position necessary hardware made out of stainless steel (grade-304/306) as per manufacturer's specification and architects instructions like : (a) Door knob (b) Thumbturn (c) Gravity hinge (d) Coat hook (e) Aluminum H Shape Toprail size 125x70xT5 (f) Noise deafening tape (g) Screws & wall plug. All screws will of SS 304 grade with stain finish. The top Supporting system will run on the concrete wall to strengthen & support the system, it will be settled on end wall with MS 'L' angles Mid & End pilaster will be fixed with the top support.			WALL HUNG model of Pacific Rest room cubicles				
1.01	Toilet Cubicle with standard dimension of 2050 MM height x 900mm width x 1500mm depth (which includes 600mm door size width).					Nos		
1.02	Toilet cubicles front partition with standard dimension of 2050 MM height x 900 mm width (which includes 600mm door width size).					Nos		
1.03	All aspects specified by the manufacturers, Pacific Product & Solutions Pacific Wall Hung MODEL or Equivalent.							

SAFFRON

Product Details

Presenting serenity and simplicity at its finest, the Saffron is the typical model for restroom cubicles which provide easy construction and high durability. The Pacific cubicle model is aesthetically designed with the extruded Powder coating aluminium top rail and polyamide hardware's, for giving a clean and a lean look to the restroom setup. Its intermediate panel comprises of one undivided piece and has no joints in between. All pilasters as well as doors are 12mm thick with chamfered edges. Thus, for those who like minimalistic designs, Saffron is the answer.



Standard dimension & Fixing details with dwg.

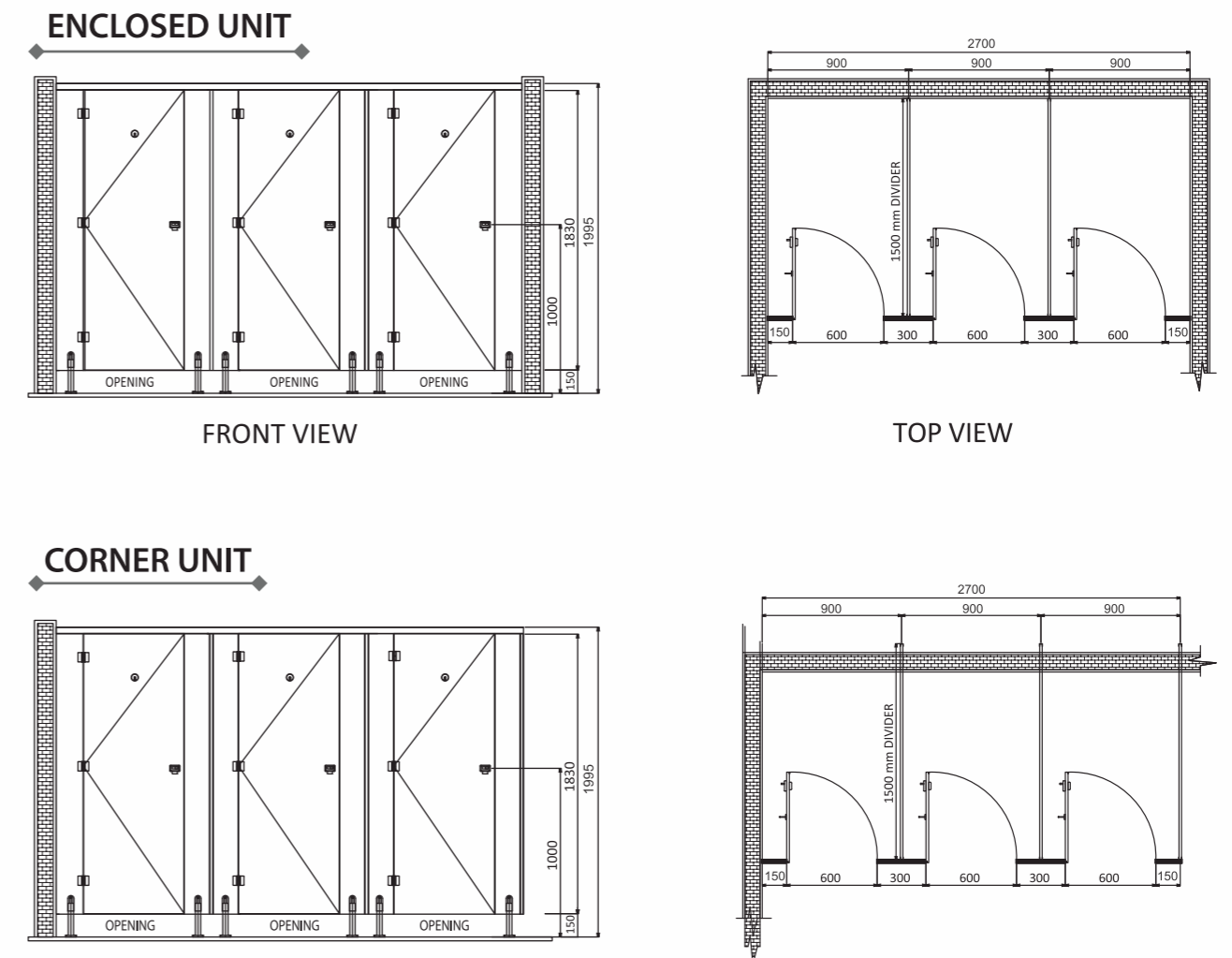

Hardware assembly processor for fixing:

The adjustable foot that supports the pilasters are made from corrosion resistant Nylon (Polyamide 6) and its base is anchored to the floor with nylon plug inserted into ground with stainless steel screws. There is a ground clearance of 150 mm. Aluminum powder coating U-channels are used to attach the divider panel to the wall as well as the mid panel. Aluminum Top Rail is used to fix the pilasters at the top (Aluminum Grade: 6063-T6 Alloy) Door stopper channel provides the non rebating doors & connecting panels with extra ordinary look. Doors are incorporated with the Noise Deafening tape to reduce the Noise effect. are incorporated with the Noise Deafening tape to reduce the noise effect.

Hardware Overview

Each restroom cubicle is equipped with the following set of hardware fittings:

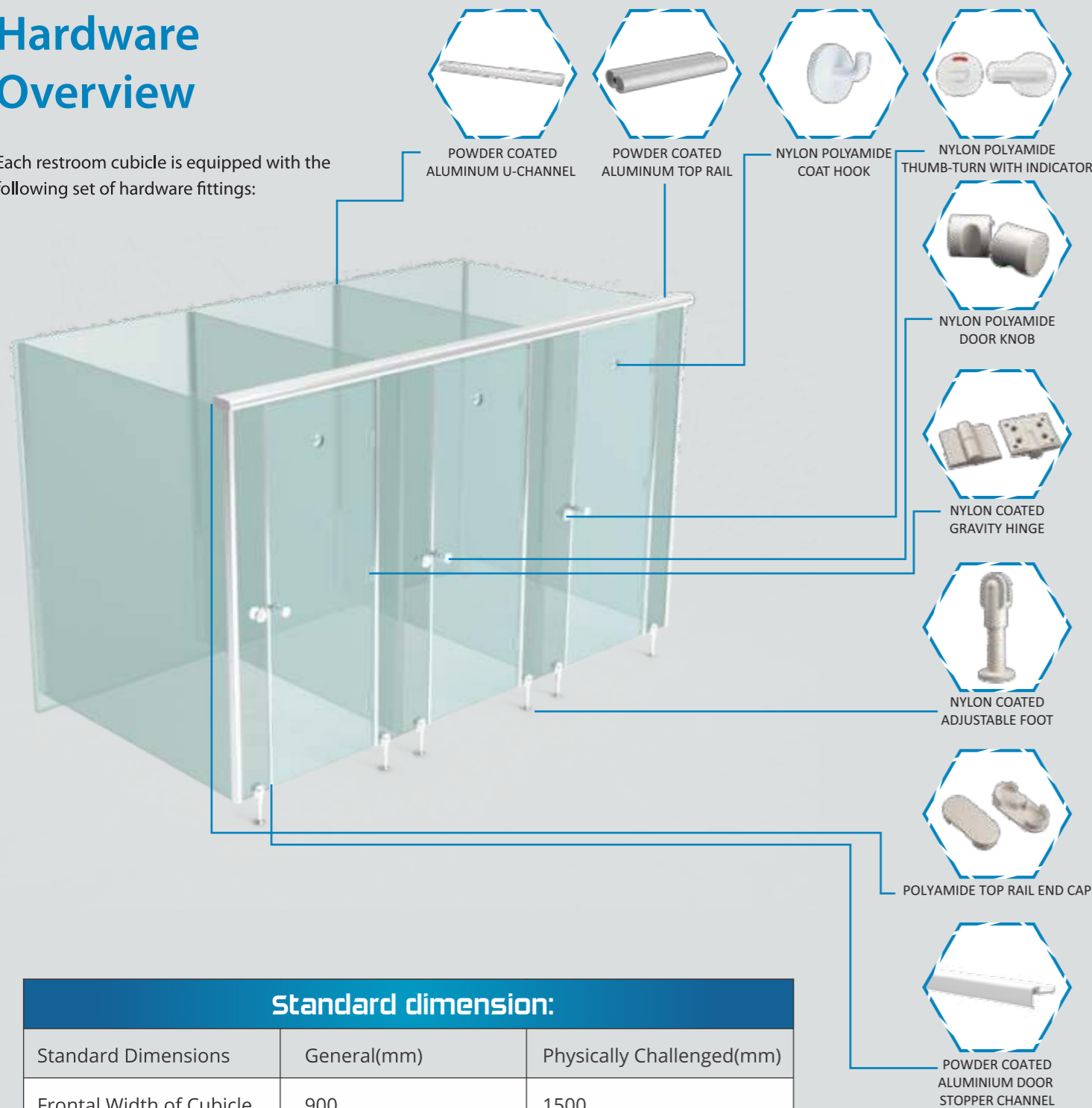

Standard dimension:

Standard Dimensions	General(mm)	Physically Challenged(mm)
Frontal Width of Cubicle	900	1500
Depth of cubicle	1500	1800
Height of entire cubicle	1995	1995
Width of Door	600	900
Height of Door	1790	1790

SAFFRON

BOQ : Toilet partitions work

S no.	Item description	Approved make	Basic price	Remarks Floor	Qty Total	Unit	Rate	Amount
1.00	Partitions & Associated works							
	Toilet Cubicles							
	Providing and fixing Pacific rest rom Cubicles SAFFRON (of following standard which includes 600mm door sizes width) made of heat bacteria, water, chemical, impact and anti bacterial resistant 12mm thick solid/wood grain compact laminate. Finish of the Compact Laminate should be Suede, which includes doors, pilaster and intermediate panels finished with approved texture/ Shades as per the details drawings & as per IS 2026 (Indian Standard) and as per the fire retardant BS- 476/97 Standard. This also details providing and fixing in position necessary hardware made out of Nylon Polyamide(Nylon-6) & Aluminium grade 6063 alloy as per manufacturer's specification and architects instructions like : (a) Door knob (b) Thumbturn) (c) Gravity hinge (d) Coat hook (e) Adjustable foot (f) Toprail (g) U Channel (h) Door stopper channel (i) Noise deafening tape (j) Screws & wall plug. The top fitting should consist of Aluminium anodized toprail which will get fixed with pilasters. All screws will of SS 304 grade with stain finish. All pilaster are supported by SS bottom cladding, The base of the bottom cladding will be anchored to the floor with a clearance height upto 155 mm.	Saffron model of Pacific Rest room cubicles						
1.01	Toilet Cubicle with standard dimension of 2000 mm height x 900mm width x 1500mm depth (which includes 600mm door size width).					Nos		
1.02	Toilet cubicles front partition with standard dimension of 2000mm height x 900 mm width (which includes 600mm door width size).					Nos		
1.03	All aspects specified by the manufacturers, Pacific Product & Solutions Pacific SAFFRON MODEL or Equivalent.							

SPLENDOR

Product Details

The Splendor is your answer when aesthetics and ease are needed in renovation projects. Using existing intermediate bricks wall, with the usage of existing intermediate brick walls this model fits in perfectly as it suffices only the door requirements. Thus PD Door replaces the traditionally used door setup with a 12mm thick compact Laminate boards come in varied designs and colors along with aluminum and nylon polyamide-6 grade hardware's.



Standard dimension & fixing details with dwg.

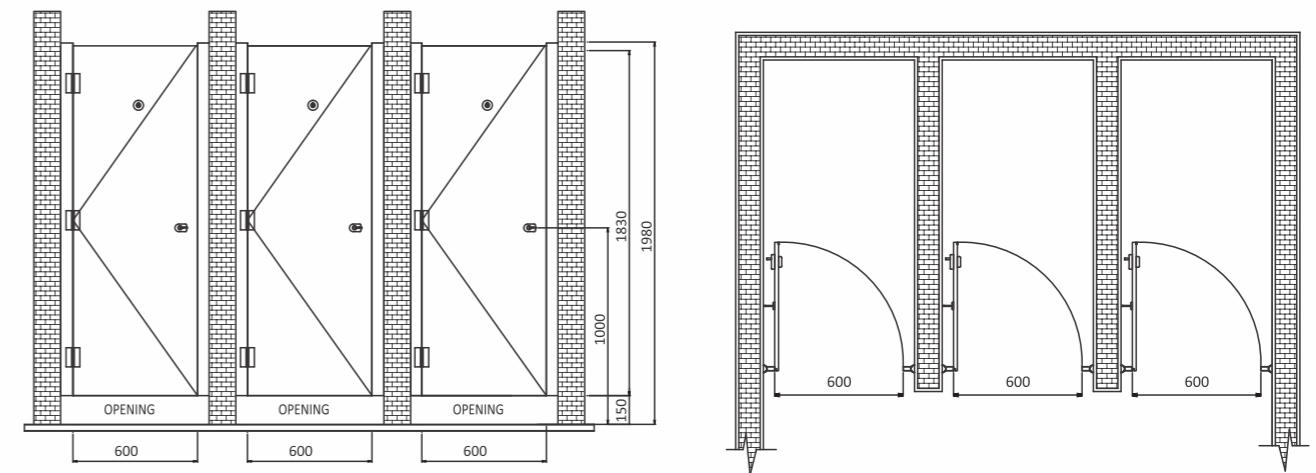

FRONT VIEW (EU)

TOP VIEW (CU)

Hardware assembly processor for fixing:

Aluminum 'D' shaped poles are fixed in the wall on both sides with SS Screws and wall plugs, maintaining the floors clearance of 150mm, each door is mounted on D shaped pole with 3 hinges. The poles are affixed rubber sponge/ lining to reduce the noise.

Hardware Overview

Each restroom cubicle is equipped with the following set of hardware fittings:

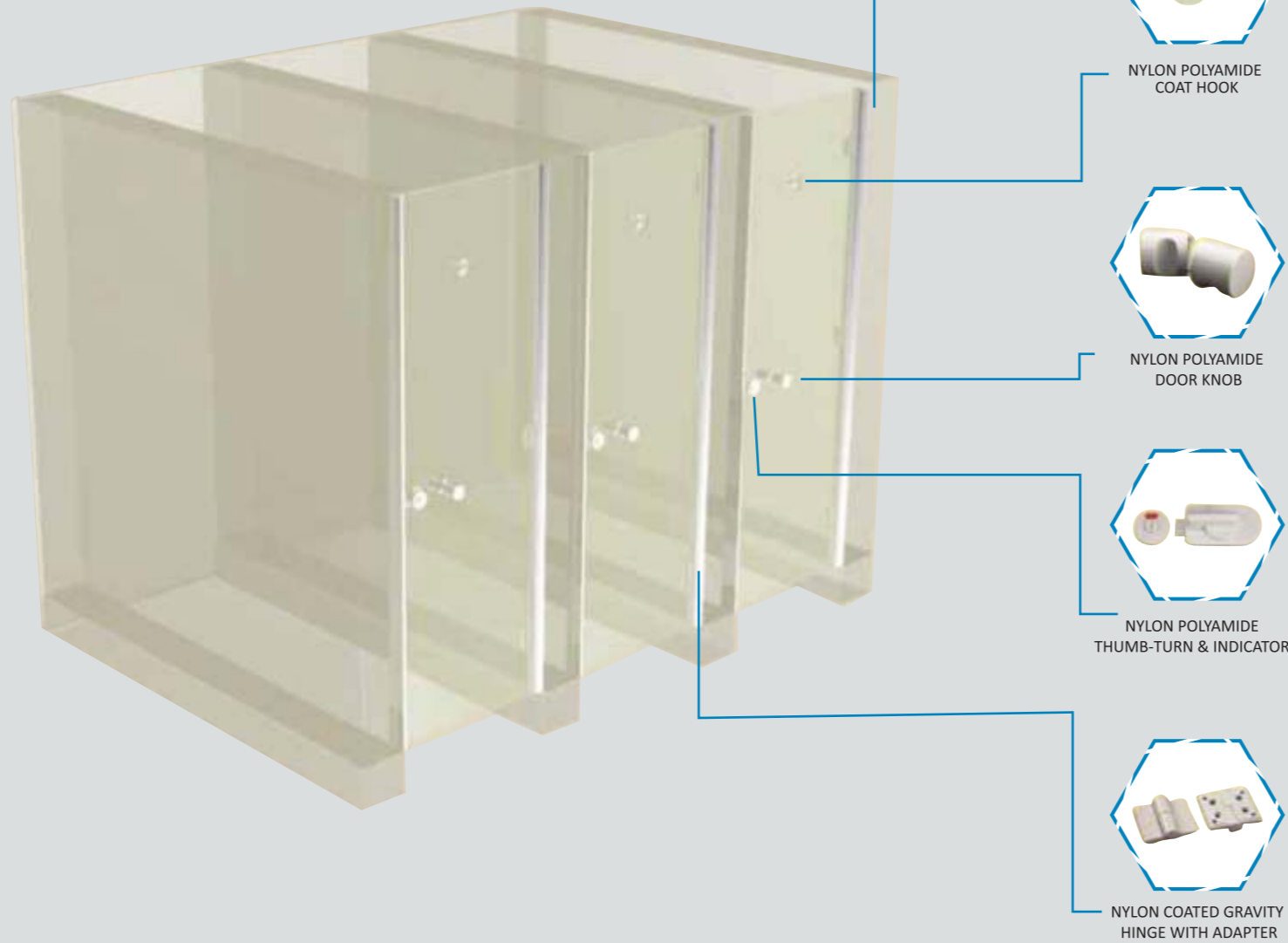

Standard dimension:		
Standard Dimensions	General(mm)	Physically Challenged(mm)
Frontal Width of Cubicle	600	900
Height of entire cubicle	1980	1980
Height of Door	1830	1830

SPLENDOR

BOQ : Toilet partitions work

S no.	Item description	Approved make	Basic price	Remarks Floor	Qty Total	Unit	Rate	Amount
1.00	Partitions & Associated works							
	Toilet Cubicles							
	<p>Providing and fixing Pacific restroom cubicles SPLENDOR of following standard which include 600mm door size (width), made of heat, bacteria water, chemical impact, anti bacterial resistant. 12mm solid/wood grain Laminate. Finish of the compact laminate should be suede. Which include doors, pilaster and intermediate panel finished with approved textures/shades as per the details drawings & as per IS 2026 (Indian Standard) and as per the fire retardant BS-476/97 Standard. This also details providing and fixing in positions necessary hardware made out of Nylon Polyamide grade-6 and aluminum Grade 6063-T6 as per manufacturer specification and architects instructions like- a) Latch Lock indicator b) Door knob c) Gravity Hinges d) Coat hook e) Aluminum D post channel f) Noise deafening tape g) Screws & wall plug .</p> <p>Alluminum D post channel of 35mm dia which should be fixed to the wall with SS -304 screws, door is gripped the poles by an arrangement of hinge adaptor and hinges. Alluminum poles are incorporated with the rubber strip to reduce the noise effect.</p>	SPLENDOR model of Pacific Rest room cubicles						
1.01	Toilet cubicle with standard dimension of 1980mm height x 600mm to 900mm width.					Nos		
1.02	Toilet cubicles front partition with standard dimension of 2400 MM height x 900 mm width (which includes 600mm door width size).					Nos		
1.03	All aspects specified by the manufactures, Pacific Restroom cubicles Splendor or Equivalent.							

SUMMER FUN

Product Details

A lovely, colourful, safe and sturdy world, especially designed for kids, creating fun and laughter zones for kids. To make sure that fun never ends, these cubicles are made using stainless steel hardware's like privacy lock, door knob, coat hook, gravity hinges U channel, shoe box and toprail, these cubicles are designed for a longer durability.

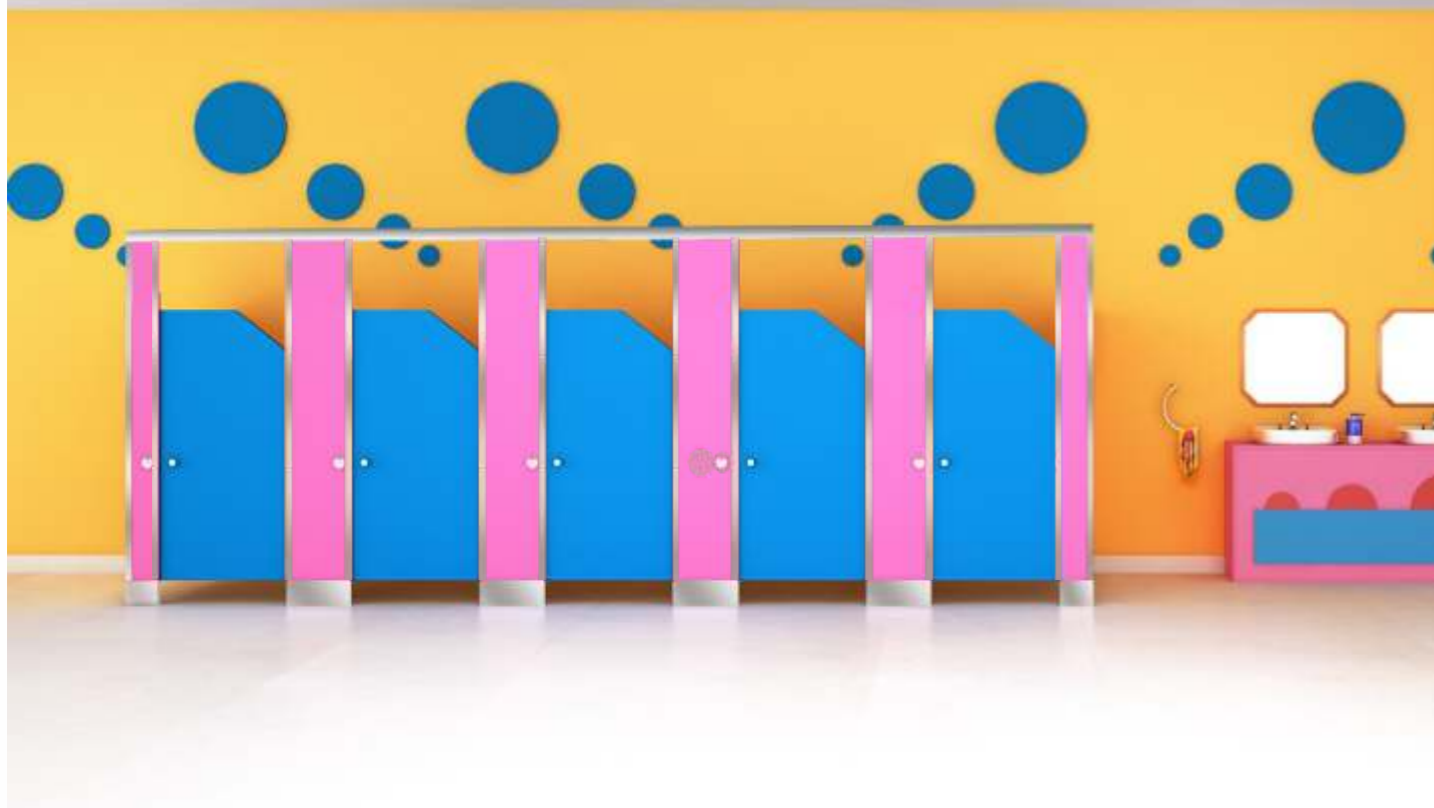

Kids Toilet

Standard dimension & Fixing details with dwg.

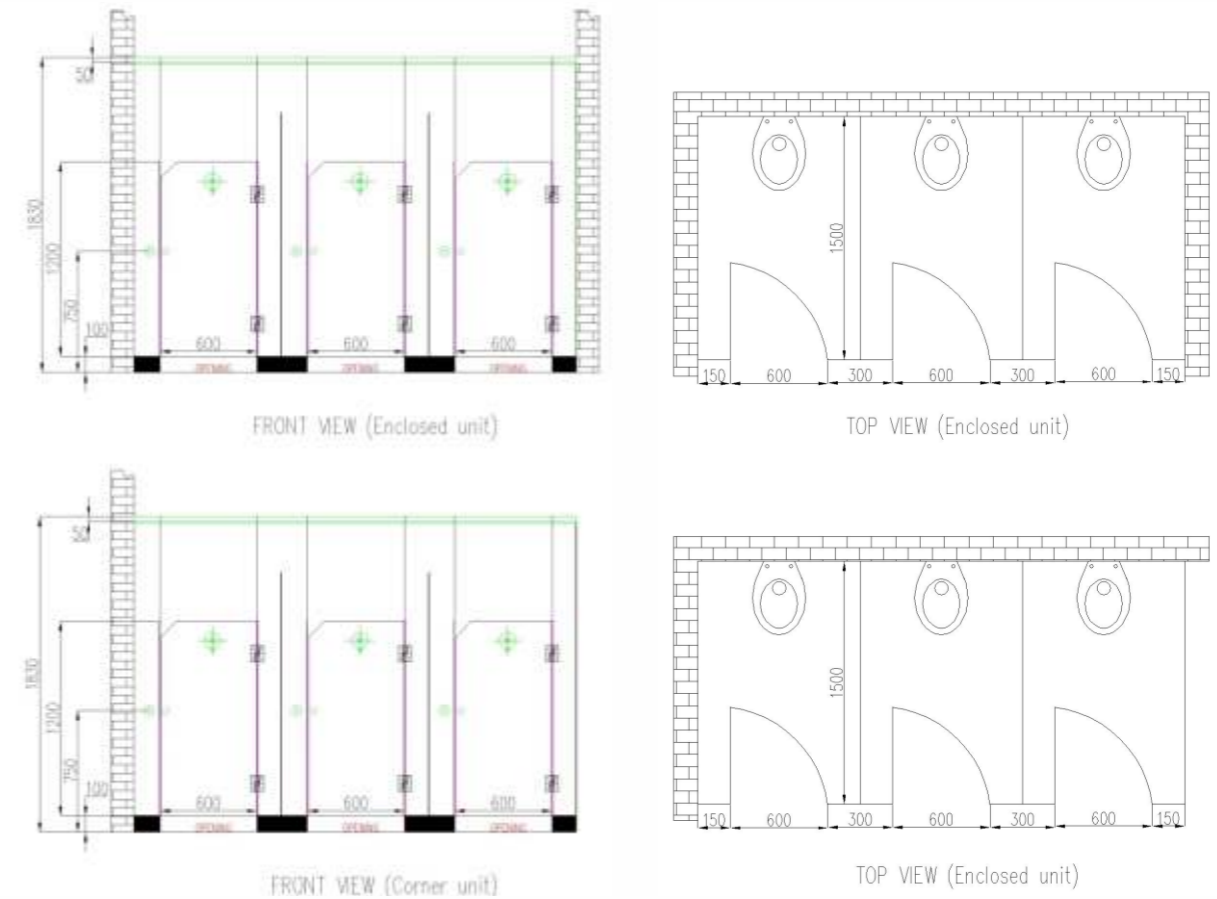

Hardware assembly processor for fixing:

All pilasters are supported by Pacific rest room cubicles- Summer Fun 12mm Box up Floor anchor with floor anchor bolt, Floor anchor is concealed with stainless steel flat box-up of height 100mm. The stainless steel Box-up is available in SS Grade 304 & 316 options. Fixing of intermediate panels to wall shall be with stainless steel grade 304 U-channel section fixed into wall with SS 304 screw inserts. All pilasters will be fixed with a SS(Grade 304) top rail at the top. Doors are incorporated with the noise deafening tape to reduce the noise effect.

Standard dimension:

Standard Dimensions	General(mm)	Physically Challenged(mm)
Frontal Width of Cubicle	900	1500
Depth of cubicle	1500	1800
Height of entire cubicle	1830	1830
Width of Door	600	900
Height of Door	1200	1200

SUMMER FUN

BOQ : Kids Toilet partitions work

S no.	Item description	Approved make	Basic price	Remarks Floor	Qty Total	Unit	Rate	Amount
1.00	Partitions & Associated works							
	Toilet Cubicles							
	<p>Providing and fixing Pacific rest rom Cubicles Summer Fun (of following standard which includes 600mm door sizes width) made of heat bacteria, water, chemical, impact and anti bacterial resistant 12mm thick solid/wood grain compact laminate. Finish of the Compact Laminate should be Suede, which includes doors, pilaster and intermediate panels finished with approved texture/ Shades as per the details drawings & as per IS 2026 (Indian Standard) and as per the fire retardant BS- 476/97 Standard. This also details providing and fixing in position necessary hardware made out of stainless steel (grade- 304/306) & Aluminium grade 6063 alloy as per manufacturer's specification and architects instructions like : (a) Door knob (b) Thumb turn (c) Gravity hinge (d) Coat hook (e) Shoe box (f) Toprail (g) U Channel (h) Door stopper channel (i) Noise deafening tape (j) Screws & wall plug. The top fitting should consist of Aluminium anodized top rail which will get fixed with pilasters. All screws will of SS 304 grade with stain finish. All pilaster are supported by SS bottom cladding, The base of the bottom cladding will be anchored to the floor with a clearance height up to 100 mm.</p>	Summer Fun model of Pacific Rest room cubicles						
1.01	Toilet Cubicle with standard dimension of 1830 mm height x 900mm width x 1500mm depth (which includes 600mm door size width).					Nos		
1.02	Toilet cubicles front partition with standard dimension of 1830mm height x 900 mm width (which includes 600mm door width size).					Nos		
1.03	All aspects specified by the manufacturers, Pacific Product & Solutions Pacific Summer Fun MODEL or Equivalent.							

AZALEA

Product Details

Games. They always excite kids. And to give a daily dose of excitement to kids we present Azalea Restroom cubicle theme. Inspired by the kids, for the kids, this design will never run out of excitement. Ensuring these bowling pins don't fall like the real ones, they are being supported by stainless and U-channels, SS-shoe box plate, MS-base plate, rubber noise deafening tape, screws and wall plugs. Let the fun game begin.

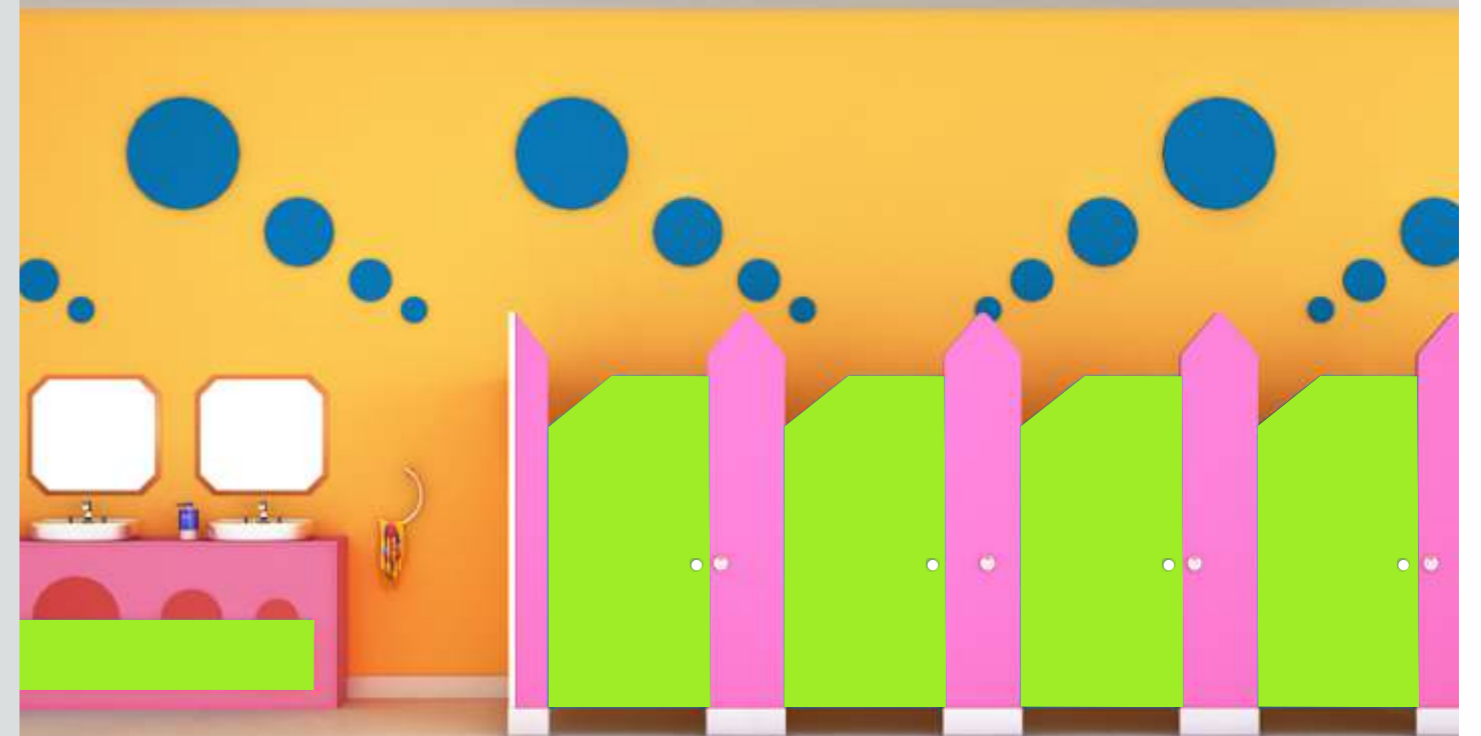

Standard dimension & fixing details with dwg.

ENCLOSED UNIT

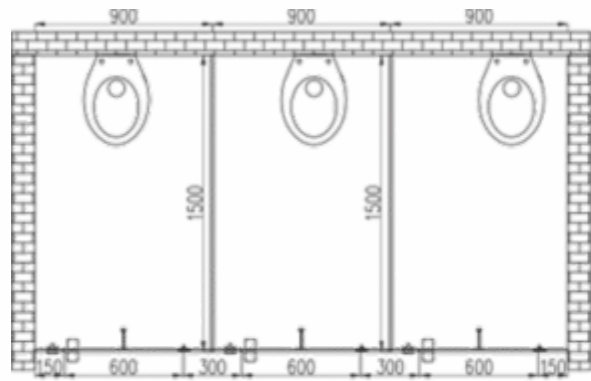

Top View

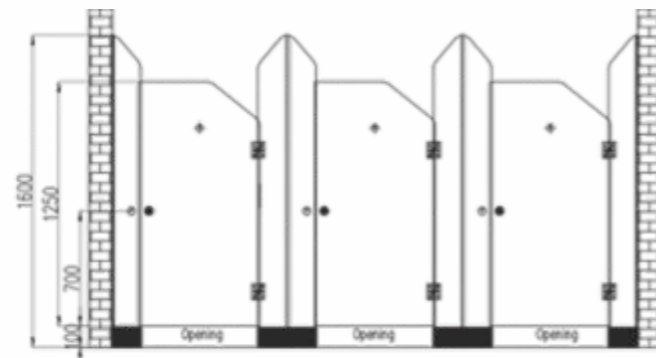

Front View

CORNER UNIT

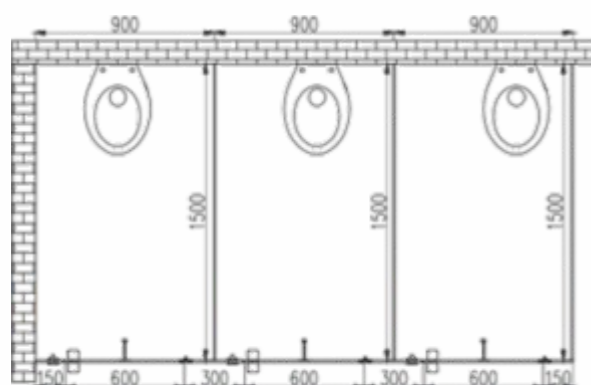

Top View

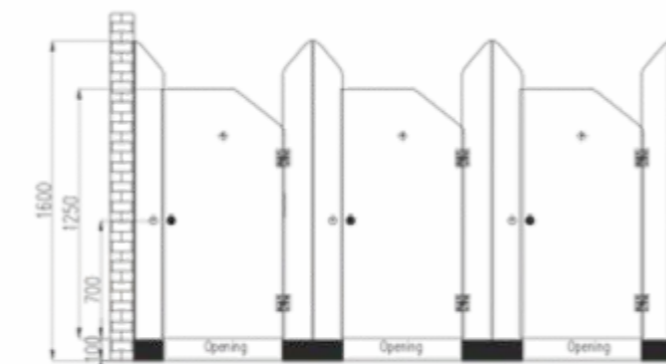

Front View

Hardware assembly processor for fixing:

All pilasters are supported by L-bracket with floor anchor bolt which is concealed with stainless steel flat box-up of height 100mm. The stainless steel box-up is available in SS Grade 304 and 316 options. The intermediate panels are fixed onto the wall with stainless steel (Grade-304) U-channel section and SS 304 screw insert

Hardware Overview

Each restroom cubicle is equipped with the following set of hardware fittings:

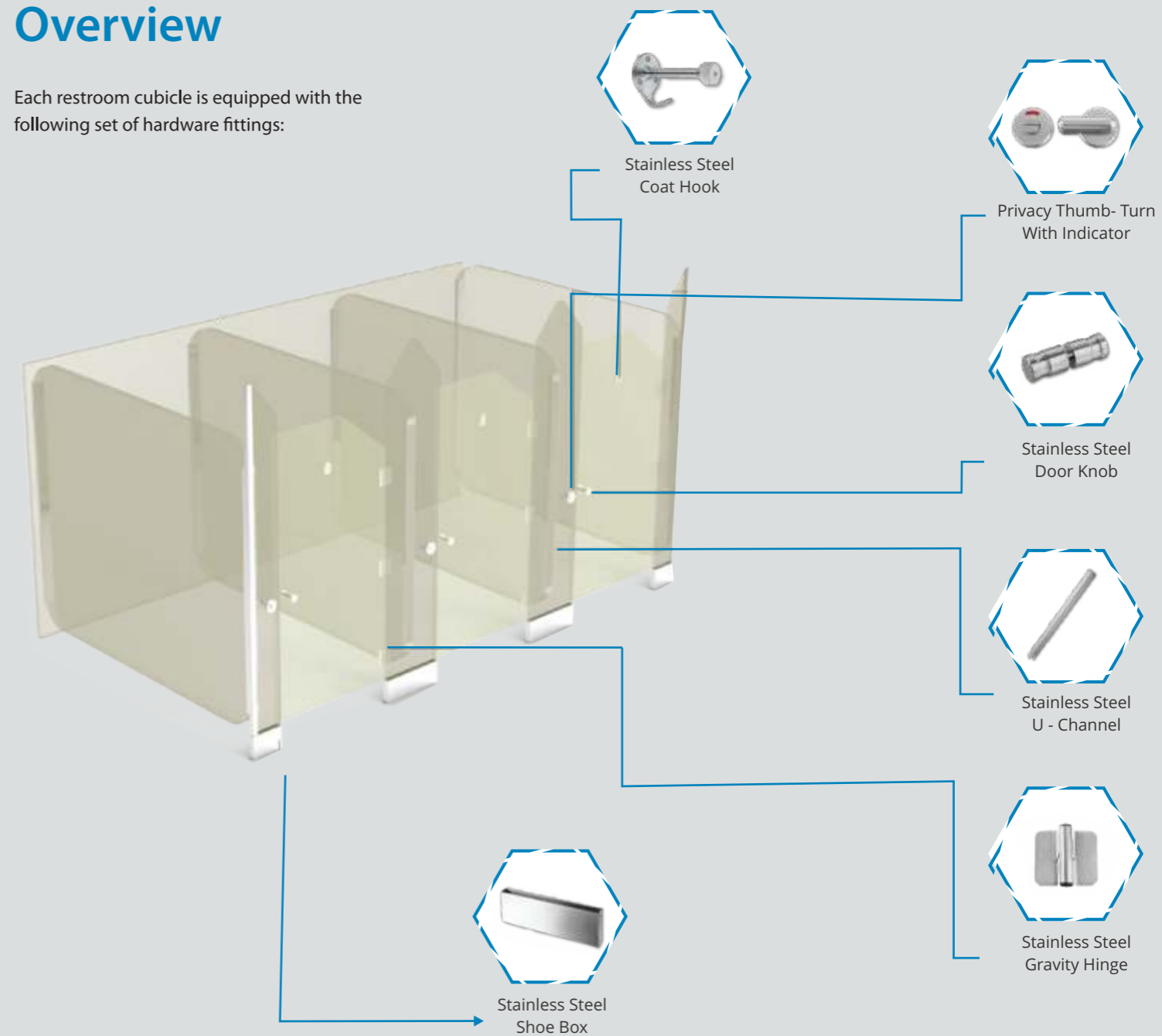

Standard dimension:

Standard Dimensions	General(mm)	Physically Challenged(mm)
Frontal Width of Cubicle	900	1500
Height of entire cubicle	1600	1600
Width of Door	600	900
Height of Divider	1200	1200

BOQ : Toilet partitions work

S no.	Item description	Approved make	Basic price	Remarks Floor	Qty Total	Unit	Rate	Amount
1.00	Partitions & Associated works							
	Toilet Cubicles							
	<p>Providing and fixing Pacific restroom cubicles Azalea of following standard which include 600mm door size (width), made of heat, bacteria water, chemical impact, anti bacterial resistant. 12mm solid/wood grain Laminate. Finish of the compact laminate should be suede. Which include doors, pilaster and intermediate panel finished with approved textures/shades as per the details drawings & as per IS 2026 (Indian Standard) and as per the fire retardant BS-476/97 Standard. This also details providing and fixing in positions necessary hardware made out of Stainless Steel grade-304/316 as per manufacturer specification and architects instructions like- (a) Thumb - Turn indicator (b) Door knob (c)Gravity Hinges d) Coat hook e) U channel (f) Shoe Box (g) Noise deafening tape (h) Screws & wall plug .</p> <p>All pilaster are supported by SS bottom cladding, The base of the bottom cladding will be anchored to the floor with a clearance height up to 110 mm.</p>	Azalea model of Pacific Rest room cubicles						
1.01	Toilet cubicle with standard dimension of 1600 mm height x 900 Width mm x 1500 mm Depth.					Nos		
1.02	Toilet cubicles front partition with standard dimension of 1600 MM height x 900 mm width (which includes 600mm door width size).					Nos		
1.03	All aspects specified by the manufactures, Pacific Restroom cubicles Azalea or Equivalent.							

Urinal modesty panel

Pacific Product and Solutions give a new meaning to your rest room areas with vibrant coloured Urinal Modesty Panel coupled with rust resistant stainless steel clamps. Packed with superior product features to provide greater privacy and hygiene to the users. The Urinal panel is manufactured using 12mm thick Compact Laminate, it provides a cleaner and well-structured look to your restroom area. It has chamfered edges with no joints in between which gives a clean and elegant look to rest room spaces



Model - A
Size 1200 mm x 500 mm



Model - C
Size 1200 mm x 450 mm



Model - B
Size 1200 mm x 450 mm



Model - D
Size 900 mm x 450 mm

HARDWARE DETAILING

Each divider panel equipped with the following hardware fittings: Stainless steel 'L' Clamp to attach the divider to the wall.



HARDWARE FIXING DETAILS

Stainless Steel L Clamp hardware fittings along with SS-304 grade screws are used to fix the urinal partitions on the wall.

Pacific LOCKER SYSTEMS



Locker System made using High Pressure laminates. Brilliantly designed and exceptionally durable, our restroom lockers and partitions are ideal for high humidity areas such as fitness clubs, Schools/College Hostels, swimming pools, and sports centers.

Available in a wide range of styles, sizes, configurations and colors to achieve a perfect match with your services and interior designs, our restroom locker systems are extra-tough, environment-friendly, easy-to-install and even easier to use.

What's more, locker partitions come with unique Anti-bacterial property that makes them a superb choice for hygiene concern areas.

Z SHAPE



1 TIER

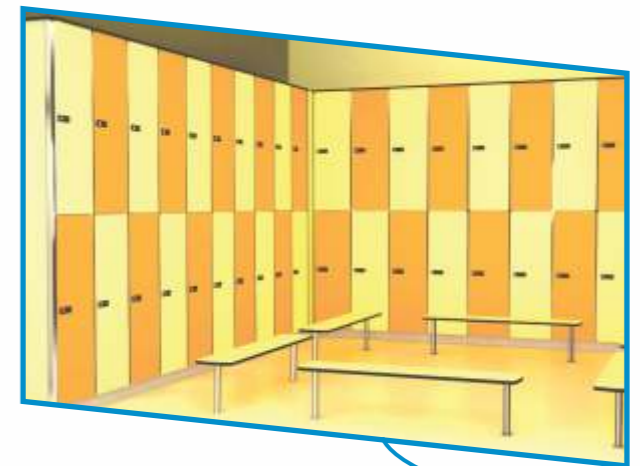

2 TIER



3 TIER



4 TIER



5 TIER

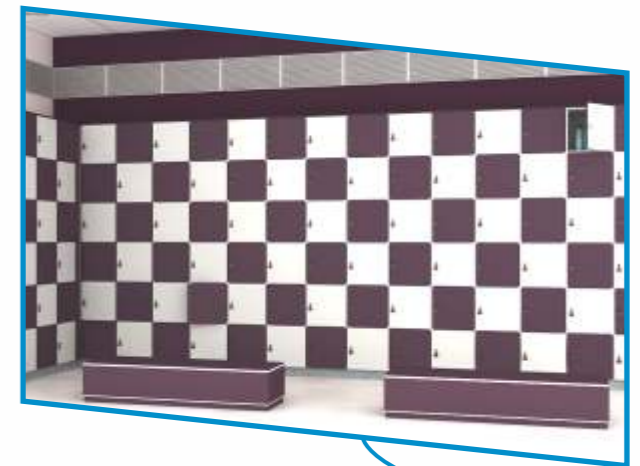

6 TIER

LOCKERS LAYOUT

1 TIER



DIMENSION DETAILING

Standard Dimensions	Size (mm)
Width of Locker	300
Depth of Locker	450
Height of Locker	1800

2 TIER



DIMENSION DETAILING

Standard Dimensions	General (mm)
Width of Locker	300
Depth of Locker	450
Height of Locker	895

3 TIER

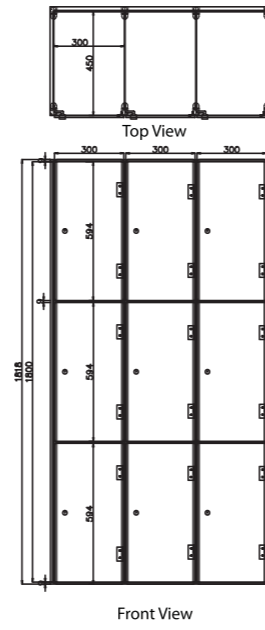

DIMENSION DETAILING

Standard Dimensions	Size (mm)
Width of Locker	300
Depth of Locker	450
Height of Locker	594

Z TYPE

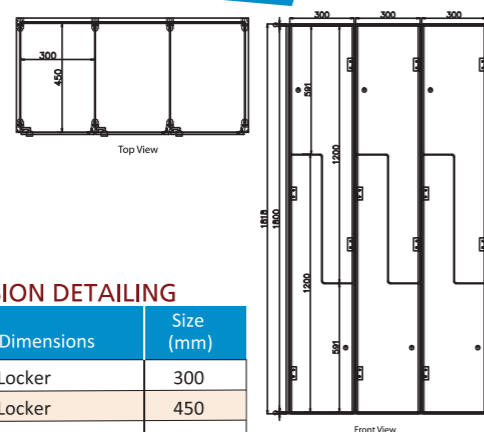

DIMENSION DETAILING

Standard Dimensions	Size (mm)
Width of Locker	300
Depth of Locker	450
Height of Locker	1200/591

4 TIER

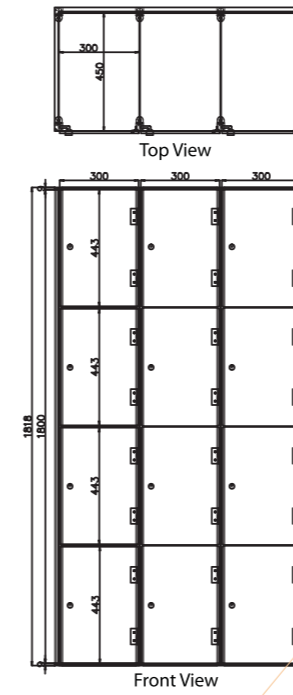

DIMENSION DETAILING

Standard Dimensions	Size (mm)
Width of Locker	300
Depth of Locker	450
Height of Locker	443

5 TIER

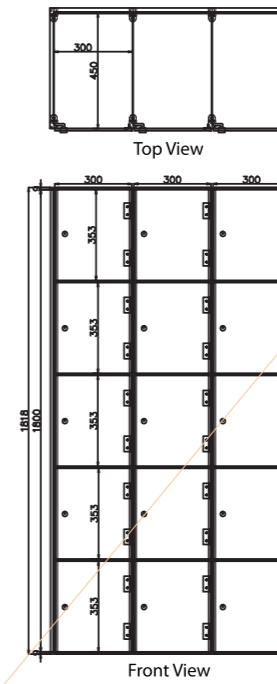

DIMENSION DETAILING

Standard Dimensions	Size (mm)
Width of Locker	300
Depth of Locker	450
Height of Locker	353

6 TIER

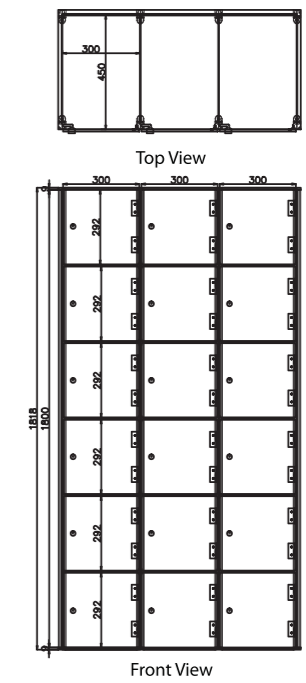

DIMENSION DETAILING

Standard Dimensions	Size (mm)
Width of Locker	300
Depth of Locker	450
Height of Locker	292

LOCKERS COMPONENT



LOCKERS HINGE



LOCKERS LEG



ALUMINUM PROFILE

WOODGRAINS & PATTERNS



Weeping Beech / 1001



Alberta Maple / 1002



Cherry / 1003



Red Maple / 1004



Wellow Tree White / 1005



Wenge Crown / 1006



Grey Stone / 1007

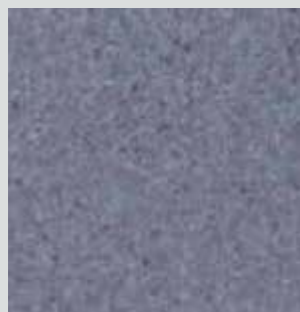

Nordic Terra / 1008

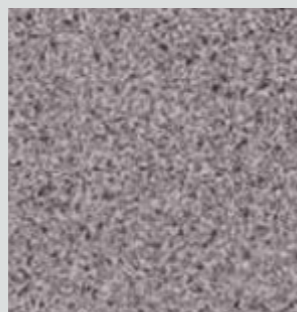

Diamond Stone / 1009



Puntinato / 1010



Pietra / 1011

SOLID COLOURS

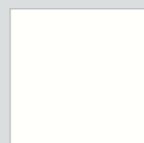

Azure White 2001

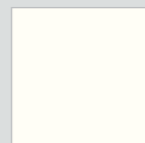

Creamy White 2002

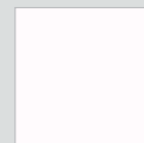

Mysore Ivory 2003



Off White 2004

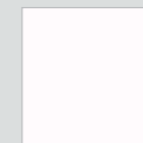

Ivory 2005

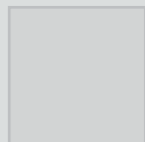

Alumina Grey 2006



Smoke Grey 2007



Ivory Grey 2008

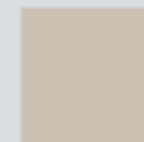

Chalk Grey 2009

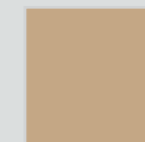

Tidal Sand 2010



Warm Grey 2011

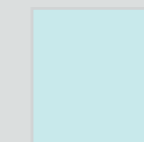

Azure / 526 SD 2012

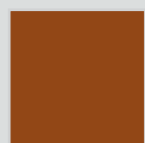

Rust Brown 2013



Cherry Brown 2014

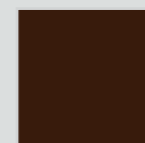

Dark Chocolate 2015



Military Green 2016



Charcoal Brown 2017

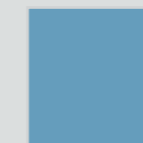

Lazuline 1018

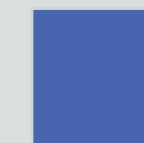

Royal Blue 1019

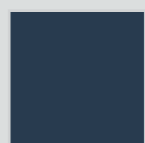

Deep Blue 2020



Charcoal Grey 2021



Black 2022



Blood Red 2023



Orange 2024



Golden Yellow 2025



Hina 2026

General Technical Specification of Compact laminate

PROPERTIES	UNIT	TEST METHOD AS PER DIN EN 438 Part 2&3: 2005	9.00mm		12.00mm		18.00 mm	
			Specified value as per BSEN 438-4: 2005	Our VALUES	Specified value as per BSEN 438-4: 2005	Our VALUES	Specified value as per BSEN 438-4: 2005	Our VALUES
CLASSIFICATION		EN 438-4- 4	CGS		CGS		CGS	
Thickness	mm	EN 438-2 - 5	9.0 ± 0.50	9.0 ± 0.40	12.0 ± 0.60	12.0 ± 0.40	18.0 ± 0.70	18.0 ± 0.50
Resistance to Dry Heat at 180° C	Rating	EN 438-2 -16	Not worse than 4	5	Not worse than 4	5	Not worse than 4	5
Resistance to Surface Wear	Rev.	EN 438-2 -10	350 (min.)	400	350 (min.)	400	350 (min.)	400
Resistance to Immersion in Boiling Water		EN 438-2 - 12						
a) Mass Increase	%		2.0 (max.)	0.48	2.0 (max.)	0.5	2.0 (max.)	0.2
b) Thickness	%		2.0 (max.)	0.7	2.0 (max.)	0.7	2.0 (max.)	0.4
c) Appearance	Rating		Not worse than 4	5	Not worse than 4	5	Not worse than 4	5
Dimensional Stability at Elevated Temperature		EN 438-2 - 17						
a) Longitudinal	%		0.30(max.)	0.15	0.30(max.)	0.15	0.30(max.)	0.15
b) Transverse	%		0.60 (max)	0.25	0.60 (max)	0.25	0.60 (max)	0.25
Resistance to Impact by Large Diameter Ball								
a) Drop Height	cm	EN 438-2 - 21	1800	2000	1800	2000	1800	2000
b) Diameter of Indentation	mm		10 (max)	4	10 (max)	4	10 (max)	4
Resistance to Scratching	N	EN 438-2 - 25	2.0 (min.)	2.5	2.0 (min.)	2.5	2.0 (min.)	2.5
Resistance to staining								
Group 1 & 2	Rating	EN 438-2 - 26	5	5	5	5	5	5
Group 3	Rating		4	≥ 4	4	≥ 4	4	≥ 4
Resistance to Colour Change								
In Xerox Arc Light (Grey scale)	Rating	EN 438-2 - 27	4 to 5	6	4 to 5	6	4 to 5	6
Resistance to Cigarette Burns	Rating	EN 438-2 - 30	Not worse than 3	4	Not worse than 3	4	Not worse than 3	4
Resistance to Water vapour	Rating	EN 438-2 - 14	Not worse than 4	5	Not worse than 4	5	Not worse than 4	5
Resistance to Craziing	Rating	EN 438-2 - 24	Not worse than 4	5	Not worse than 4	5	Not worse than 4	5
Flexural Modulus	Mpa	EN ISO 178:2003	9000 (min.)	10000-10500	9000 (min.)	10000-10500	9000 (min.)	10500-11000
Flexural Strength	Mpa	EN ISO 178:2003	80 (min.)	90-100	80 (min.)	90-100	80 (min.)	90-100
Tenstile Strength	Mpa	EN ISO 527-2:1996	60 (min.)	70-80	60 (min.)	70-80	60 (min.)	70-80
Density	g/cm ³	EN ISO 1183 -1:2004	1.35	1.40	1.35	1.40	1.35	1.40

Pacific Cladding

Interior & Exterior



Interior Paneling

PACIFIC PRODUCT & SOLUTIONS brings interior cladding with outstanding craftsmanship in vibrant colour and beautiful forms. The panels made by a bunch of paper, which is pressed with great pressure in high temperature and treated with double hardened acrylic PUR resins that unfailingly provide extremely effective all year round weather protection. especially in such varying weather conditions as in India.







PACIFIC PRODUCT & SOLUTIONS brings cladding to architects. Beautiful forms, vibrant colors, outstanding craftsmanship and facades from PACIFIC PRODUCT & SOLUTIONS all go hand in hand. Facades are panels made from laminates treated under great pressure and high temperature and treated with double hardened acrylic PUR resins that unfailingly provide extremely effective all year round weather protection. Especially in such varying weather conditions as in India.







Pacific exterior claddings are used across diverse applications but the most widely used facades or Exterior Grade Compact Laminates are building Facades. Some of the applications are as following:

- Balcony Facades • Partitions • Business entry portals • Functional constructions
- Railings • Fences • Rear ventilated facades • Exterior Façade • Attic claddings
- Ceilings • Outdoor Furniture • Sports Facilities • Sun protection • Awnings
- Public Facilities • Playground Facilities

Pacific exterior cladding stands tall above all other ways of traditional building in the following ways.

Advantages of the non-bearing, rear-ventilated facades (VHF) :

- ➔ Savings through the shorter scaffolding time.
- ➔ Installation under any weather conditions.
- ➔ Exact cost estimation of the facades is available.
- ➔ No disposal costs during the installation phase.
- ➔ Long maintenance intervals and low follow-up costs.
- ➔ Long-term value retention and appreciation of the building.

Cost Effectiveness

Sustainable and long-term construction requires cost effective solutions. Pacific product & solutions Claddings are just that! Long service life, lengthy maintenance intervals and the recyclable components are essential to Facades that stands the economy of time.

Non-Volatile Costing Parameters

Pacific product & solutions provides costing parameters that are exact and stable be it new or in case of renovations.

Key points of Construction

- ➔ Material should not be exposed to water during construction and installation. Therefore, the panels must always be able to dry out.
- ➔ Connections of facades panels to one another always have to be made in the same panel direction.
- ➔ Cladding can show deviations from being flat (see EN 438-6,5,3), and this is to be compensated for by the sub-construction being executed so that it is stable and flat
- ➔ All connections to other components or to the background must be executed firmly.
- ➔ Elastic intermediate spacers to the sub-construction elements that permit a greater tolerance than +0.5mm must definitely be avoided.
- ➔ Long-term value retention and appreciation of the building.

Assembly Parameters

Pacific exterior cladding come along with essential fasteners made using non-corrosive materials like Aluminum & Stainless Steel. A large head of these fasteners (rivets) are colour lacquered with epoxy paints so as to compliment the Pacific Cladding range and are UV coated for better color fastening properties.

- ➔ Rivet body: Aluminum Alloy 5052
- ➔ Rivet Pin : 302 AISI
- ➔ Pull off strength of rivet Pin: Min 4626N & Max 5382N

Diameter of Drill Hole in Facades Panels:

- ➔ Sliding points : 8.5mm or as required
- ➔ Fixed points : 5.1 mm
- ➔ Diameter of drill hole in the aluminum substructure: 5.1 mm

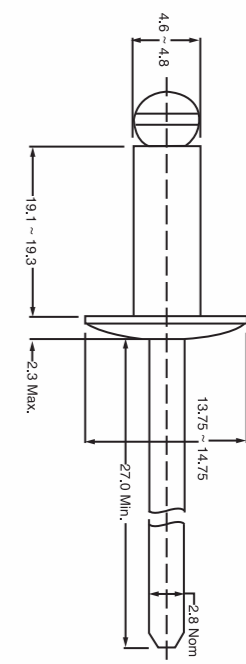
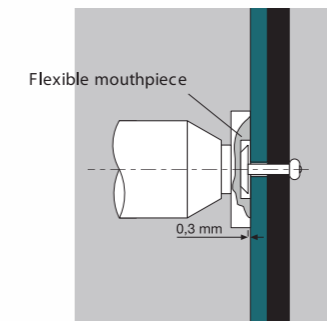
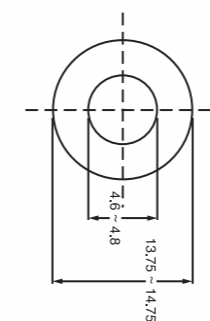

The rivets must be put in place with a flexible mouthpiece, clearance 0.3 mm

Why Exterior paneling



Fire Resistance



Light Fastness Properly



Environment Friendly



Exclusive Range



10 Year Warranty

The Technology -An Edge

The manufacturing technology make a sturdy product that can withstand extreme weather conditions and makes it perfect for exterior use

Manufacturing process

- ⇒ High bonding strength
- ⇒ Mechanically Sturdy
- ⇒ No splintering
- ⇒ Easy machinability
- ⇒ Excellent Fire Retarding properties.
- ⇒ Resistant to Termites
- ⇒ High Dimensional Stability
- ⇒ High Impact Resistance EN ISO 178
- ⇒ Bending resistant EN ISO 178

Décor Paper

- ⇒ Use of High Quality Exterior Grade Décor/Design Paper made using extreme light stable pigments and special chemical & Inks.
- ⇒ The decor paper is rated 7-8 on Blue wool scale & 3-5 on Grey scale, hence making it fit to use for exteriors.
- ⇒ Décor Papers are Certified for Light Fastness passing Xenon Light for 400 hours. Hence Optimal light-fastness (EN ISO 4892-3)

Protective Film

- ⇒ Excellent UV Performance
- ⇒ Extreme Weather Stability
- ⇒ Chemical Resistance
- ⇒ High Anti soiling properties
- ⇒ Easy Clean ability
- ⇒ Resistant to Corrosion and does not corrode.

Some of our Prestigious Projects

- Reliance JIO (North India)
- Parliament House, Delhi
- IIFCO Sadan, Delhi
- Delhi Metro Railway corporation
- Stellar IT Park ,Noida
- Stellar Business Park, G Noida
- MVN University, Palwal
- Mahendra Buildtech, Agra
- Lohia Ayurvedic Hospital, Lucknow
- Stellar Jeevan, G.Noida
- Stellar 135, Noida
- B26 Udyog Vihar Phase IV, Gurgaon
- Star mall project
- JMD, Gurgaon
- Jindal Steel Power Limited
- Modern School, Vasant Vihar
- Shriram School, Gurgaon
- LPS Global School Noida
- KidZee School, Gurgaon
- Stellar Gymkhana, G Noida,
- Indira Gandhi Athletic Stadium Guwahati
- Billabong High International School, Noida
- Spring Board Business Hub Bangalore
- JLN Stadium Delhi
- RK Khanna Stadium Delhi
- Wankher Stadium, Mumbai
- Infosys Bangalore
- GKVK Campus Bangalore
- TATA Institute Bangalore
- Royal Thai Embassy, Delhi
- SIEMENS Bangalore
- PNC Cognitio School Bangalore
- Hosur Public School bangalore
- MS Ramaiah Clollege Bangalore
- Chinmaya School Bangalore
- Virginia Mall Bangalore
- Hiranandani Eden Club House - Powai
- Hiranandani The Walk Club House -Thane
- H&M Showroom - Mumbai
- Mercedes Showroom - Thane
- Draeger India - Wasai
- SMCC Mumbai
- CULT FIT (Pan India)
- Siemens Technology, Bangalore
- CMR EKYA SCHOOL, Bangalore
- Narayana school, Bangalore
- Zomato, Hyderabad, Bangalore
- Manipal University, Mangalore
- Phoenix Marketing
- Miraj Cinema (Pan India)
- Omaxe Mall, Faridabad, Chandigarh
- N.H.A.I (Delhi Dwarka)
- Asian Fidelis Multi Speciality Hospital
- X L Health Care, Bangalore
- United Medicity Allahabad
- Shiva Statue, Udaipur
- Indiabulls Mega Mall, Jodhpur
- AIHP Udyog Vihar, Gurgaon
- Piccadily Holiday Resorts
- Shapoorji Paloonji & Company

and many mores.....